

TS
UR
OR

themabijeenkomst bouwvolume

winkelcentrum Duinzig

Den Haag, 1 oktober 2015











1 kerk en parkeerterrein



2 Willem Royaardsplein en paviljoens/kraampjes

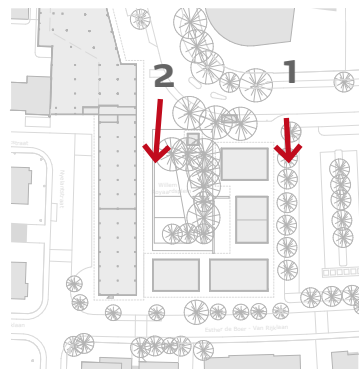

onderzoekgebied Theo Mann-Bouwmeesterlaan

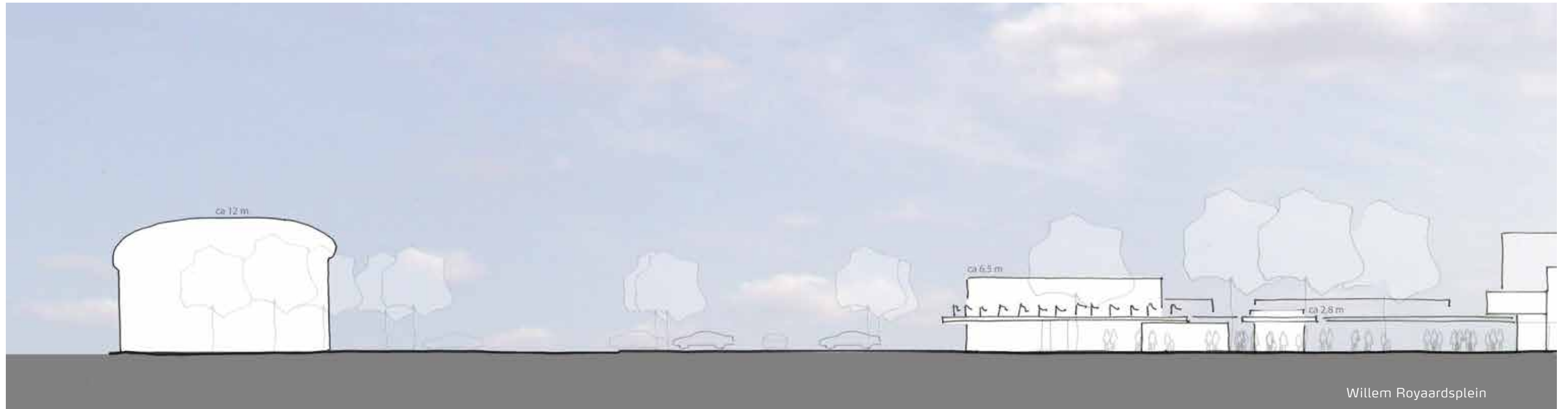

bestaand

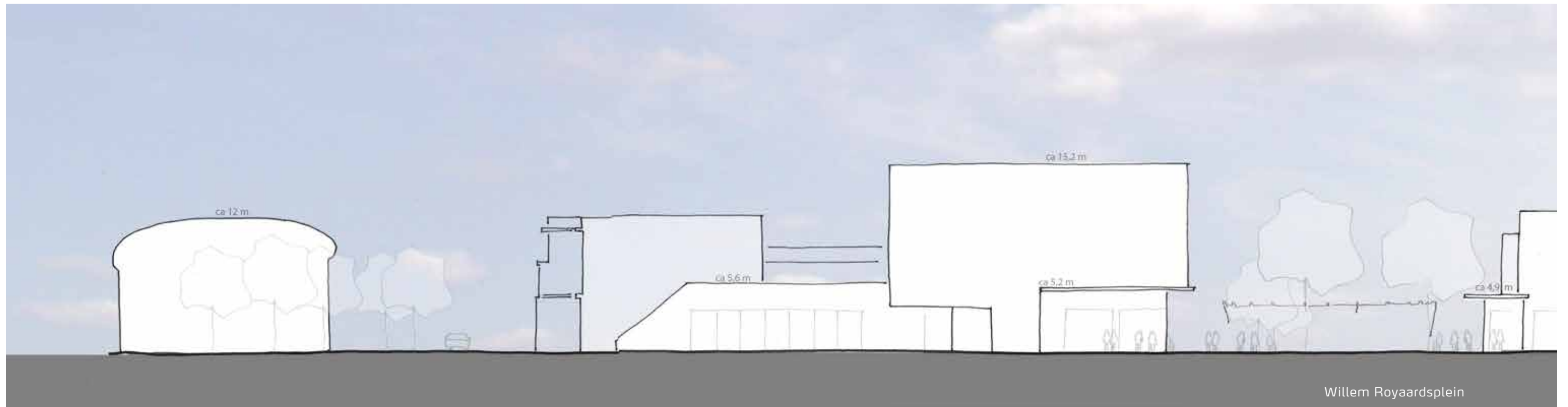

visie

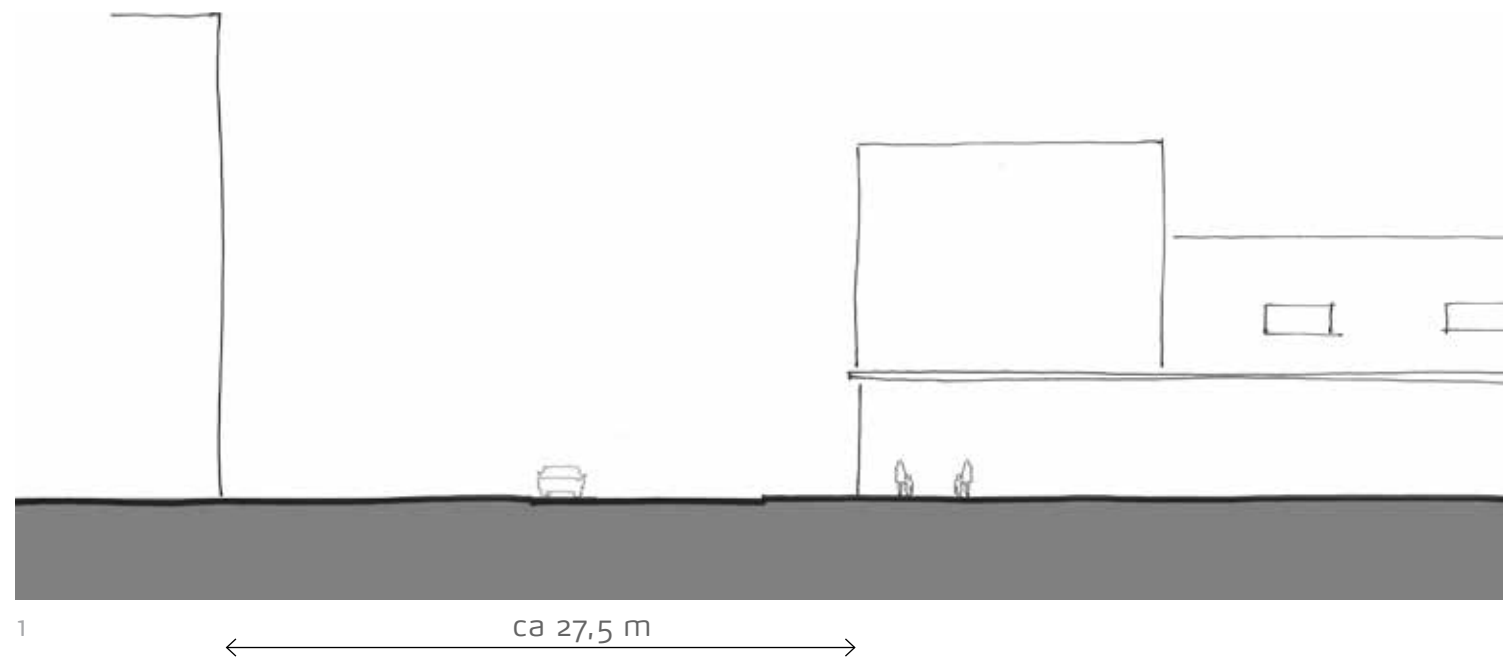
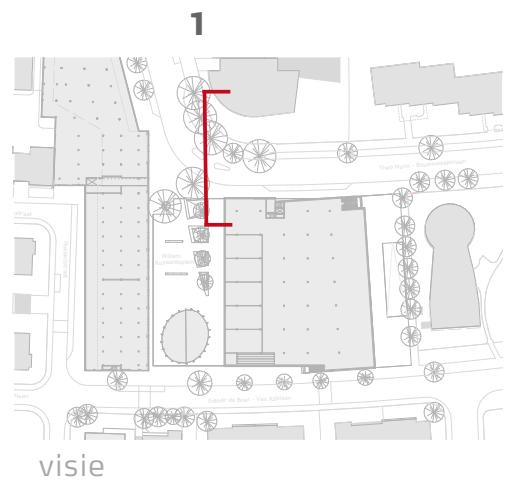
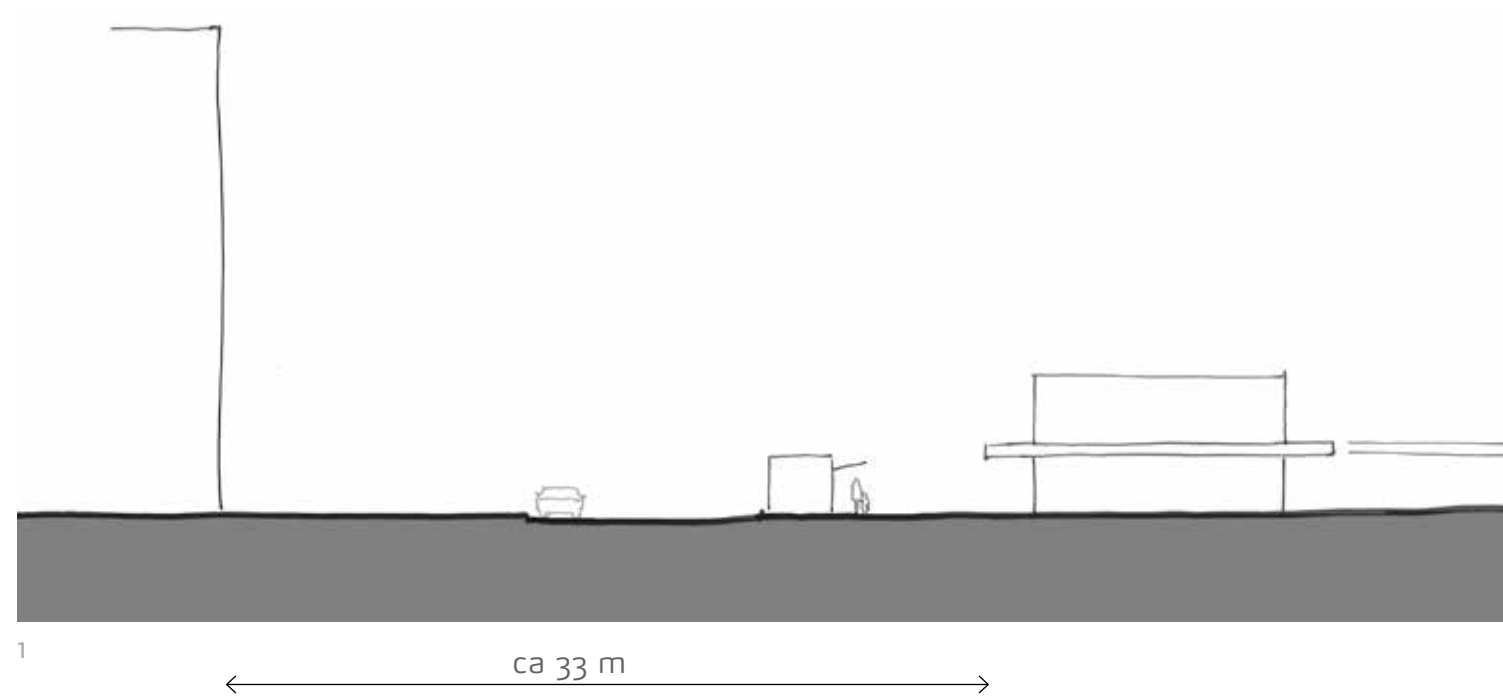
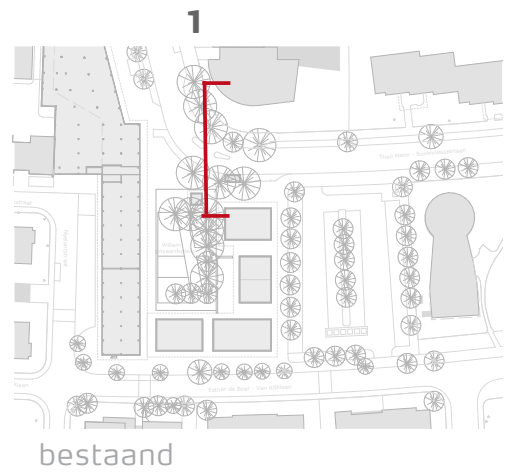

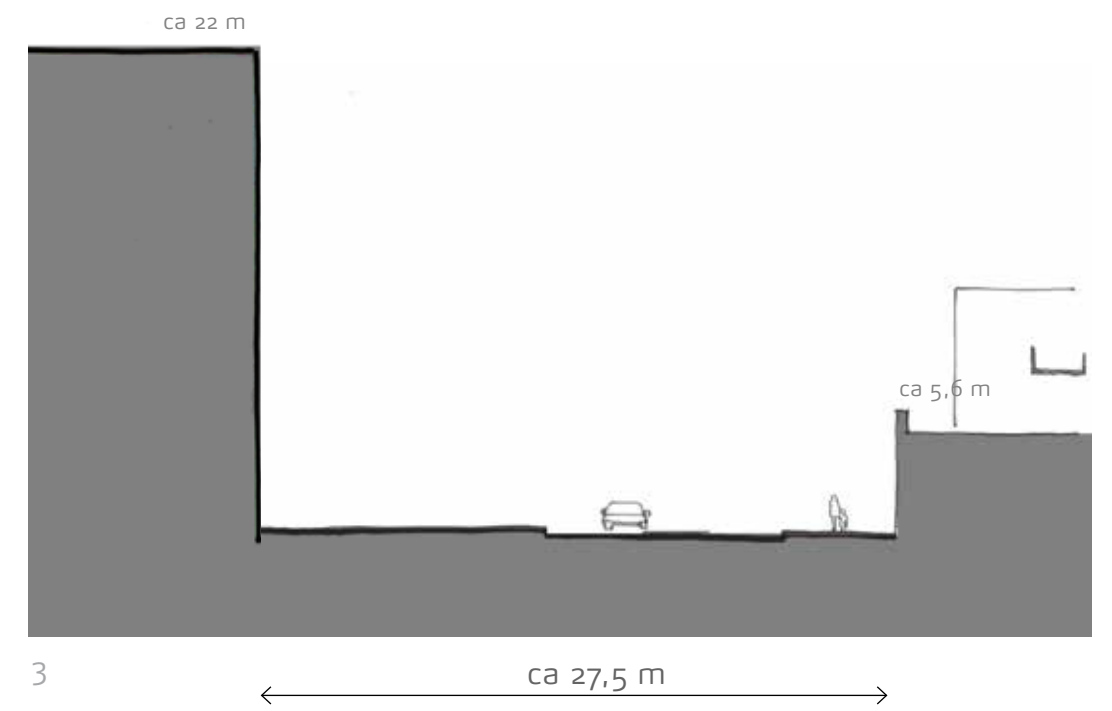
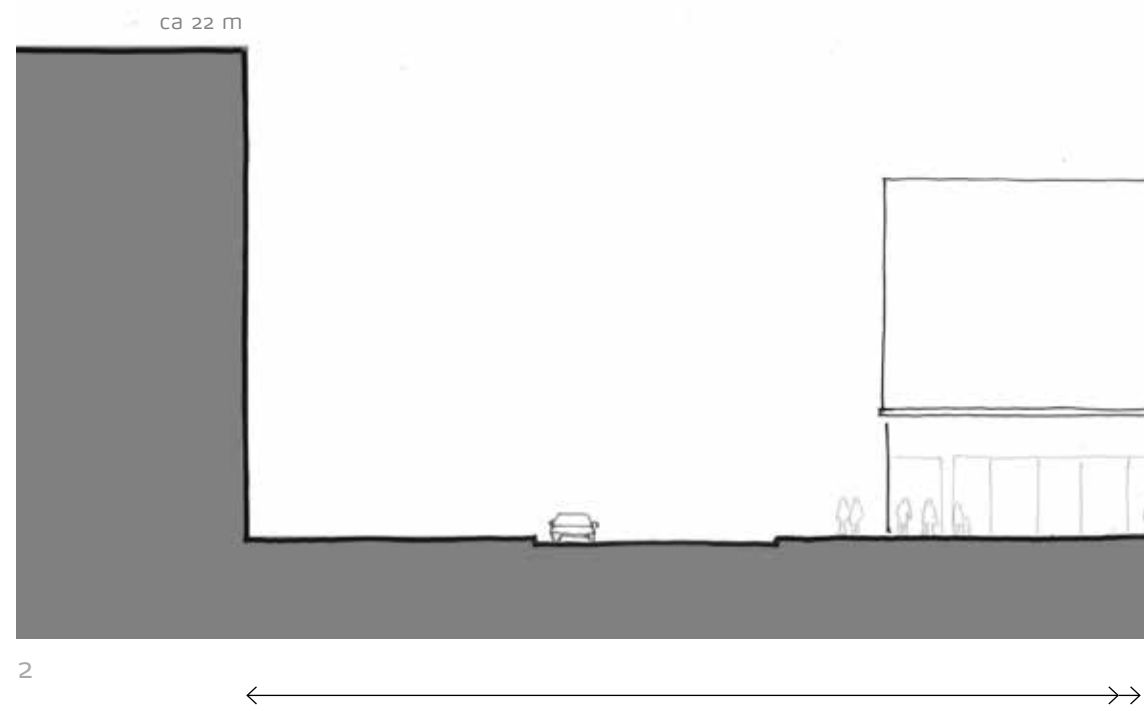
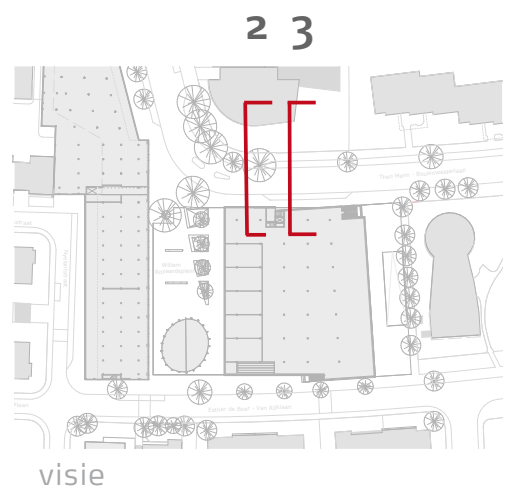
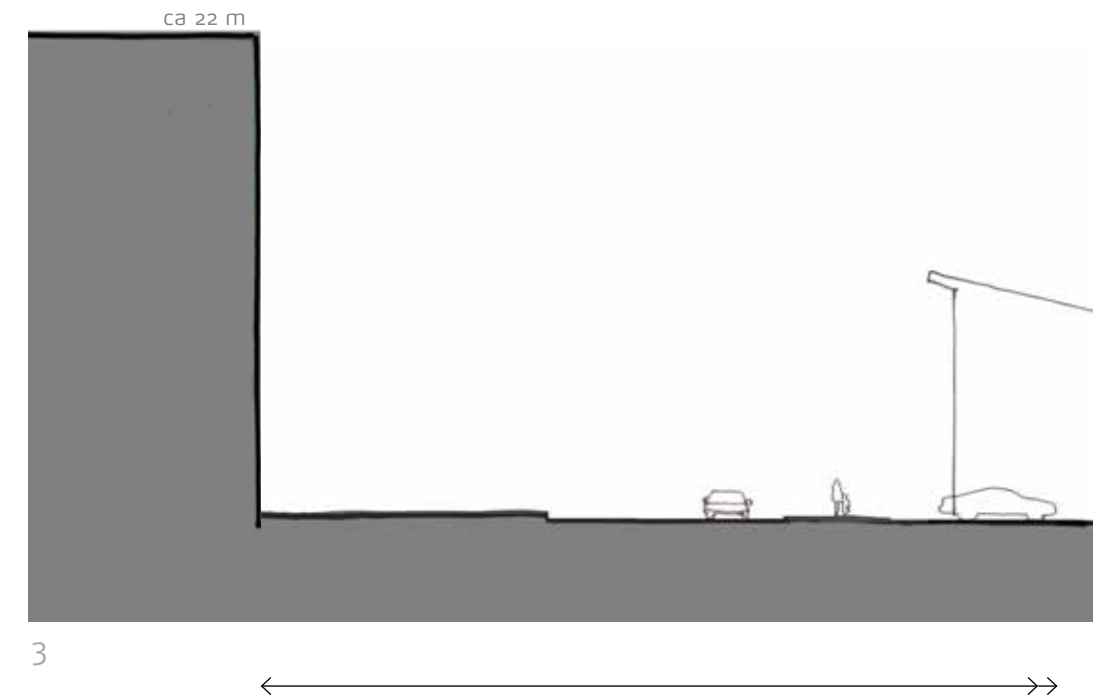
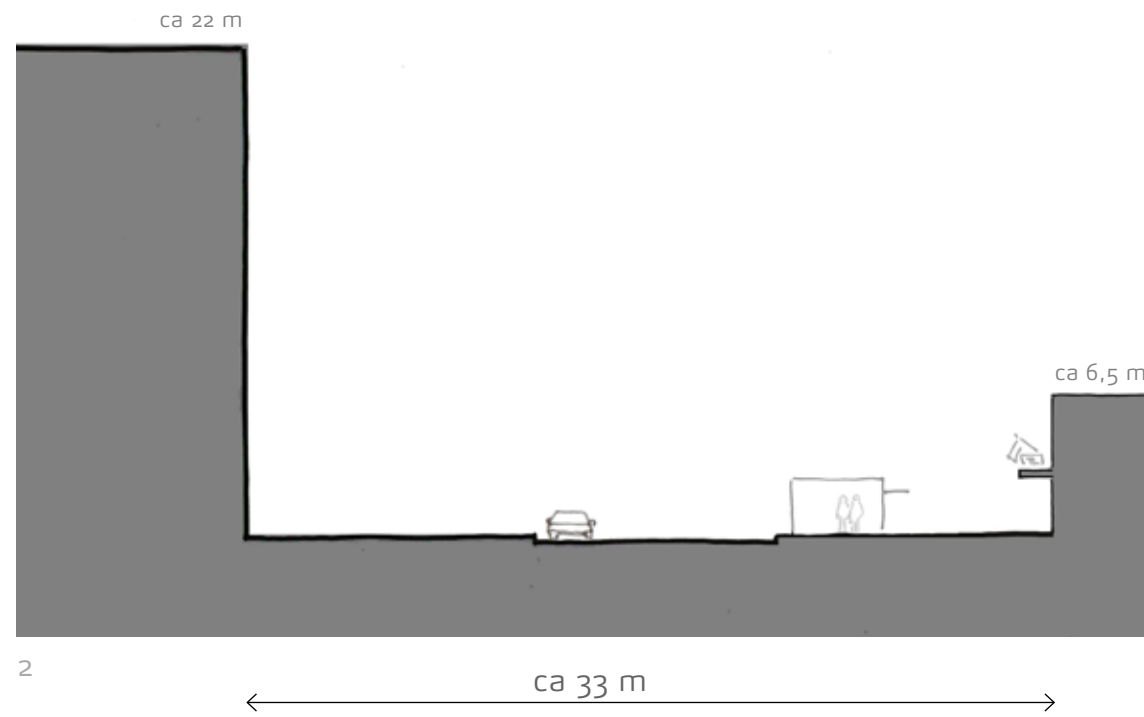

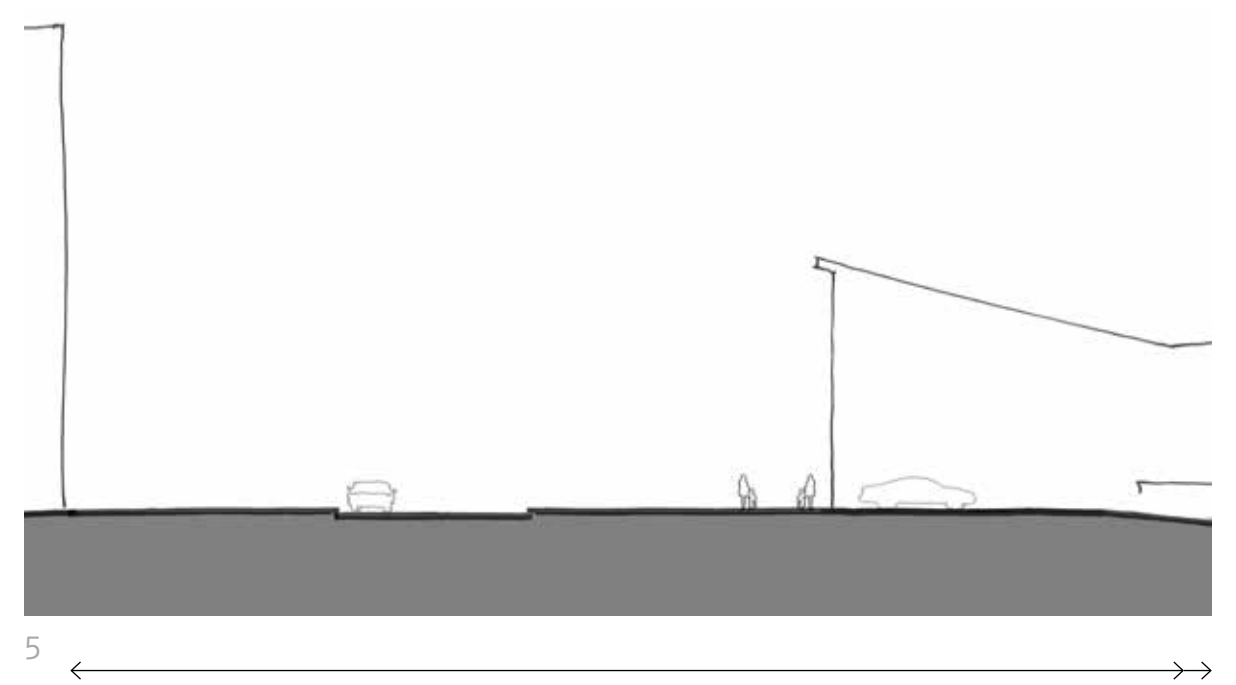
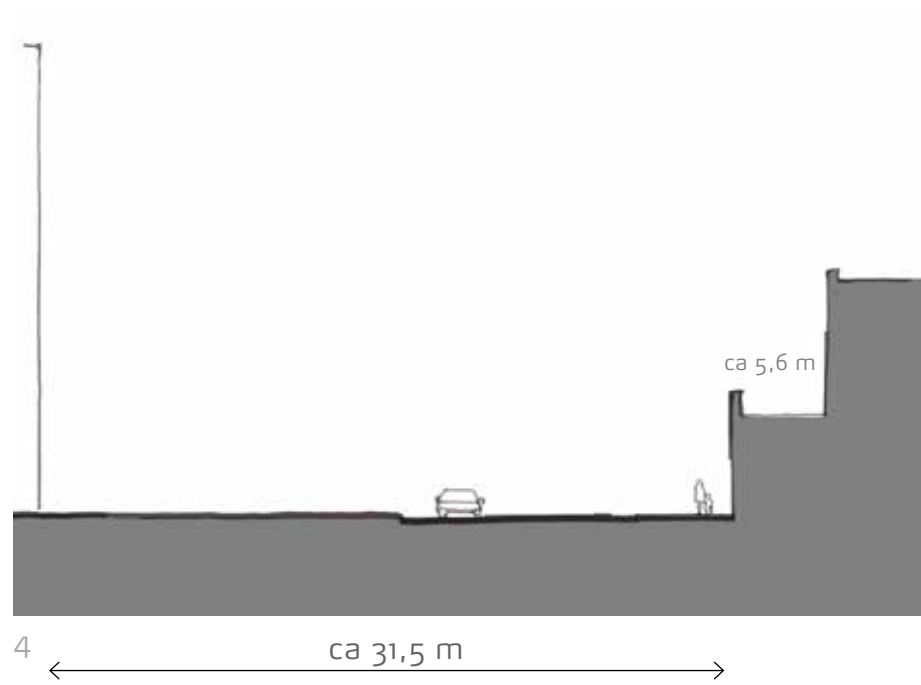
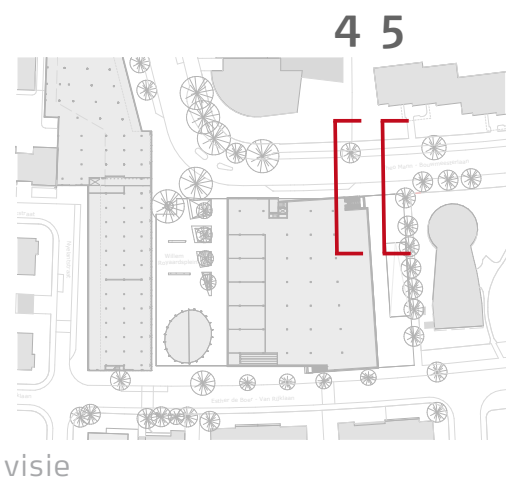
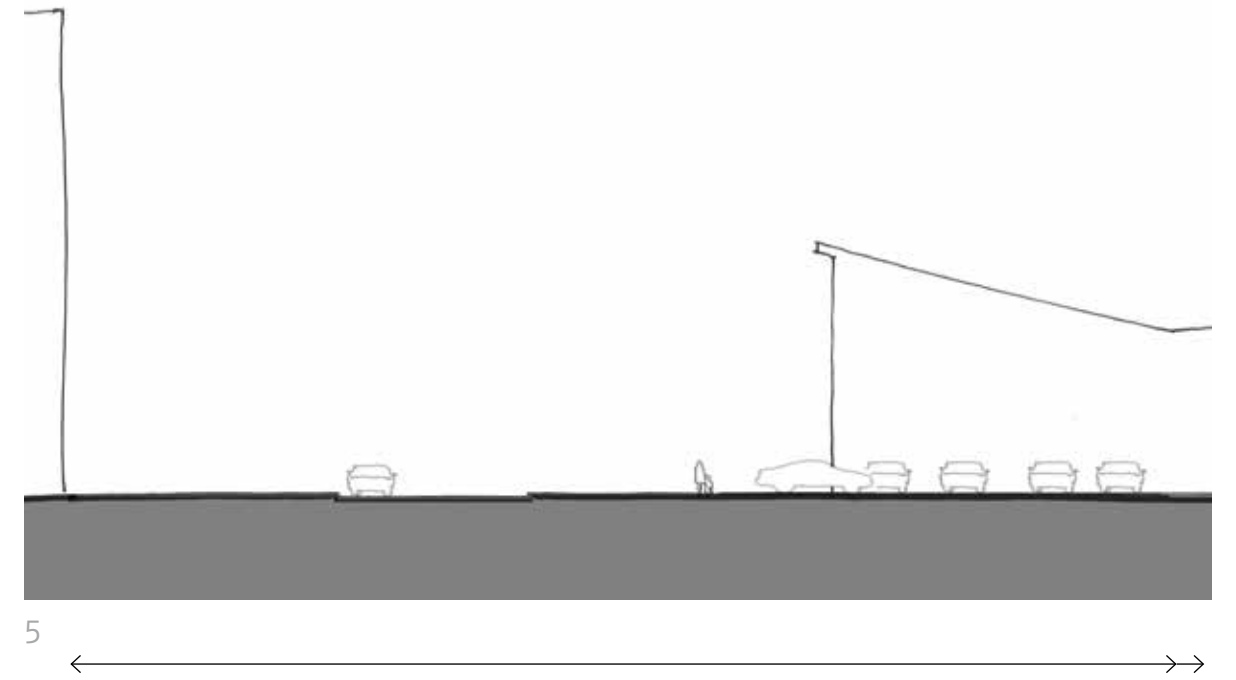
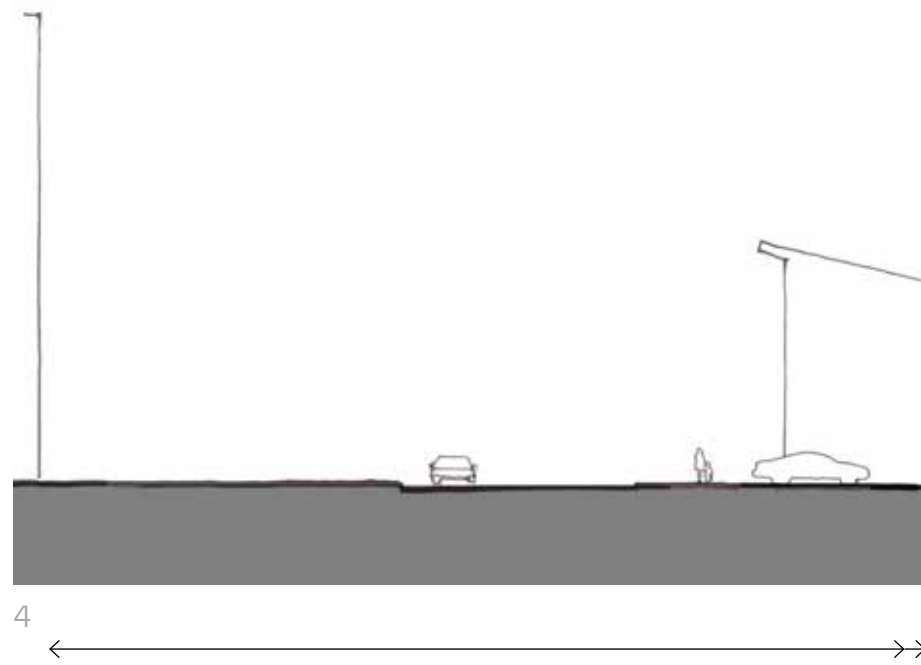
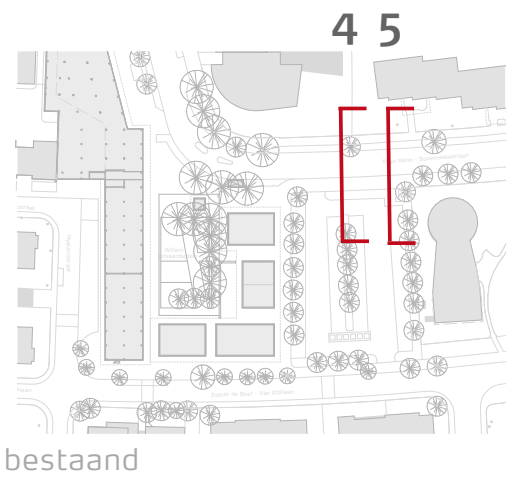





1 parkeerterrein en paviljoens



2 parkeerterrein en paviljoens

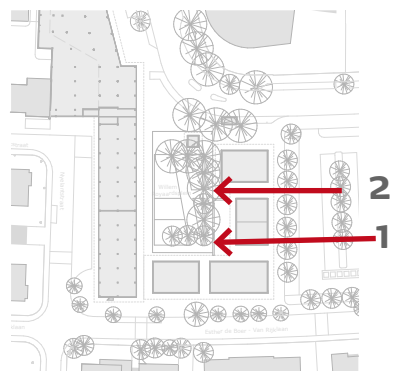

onderzoeksgebied kerk



bestaand

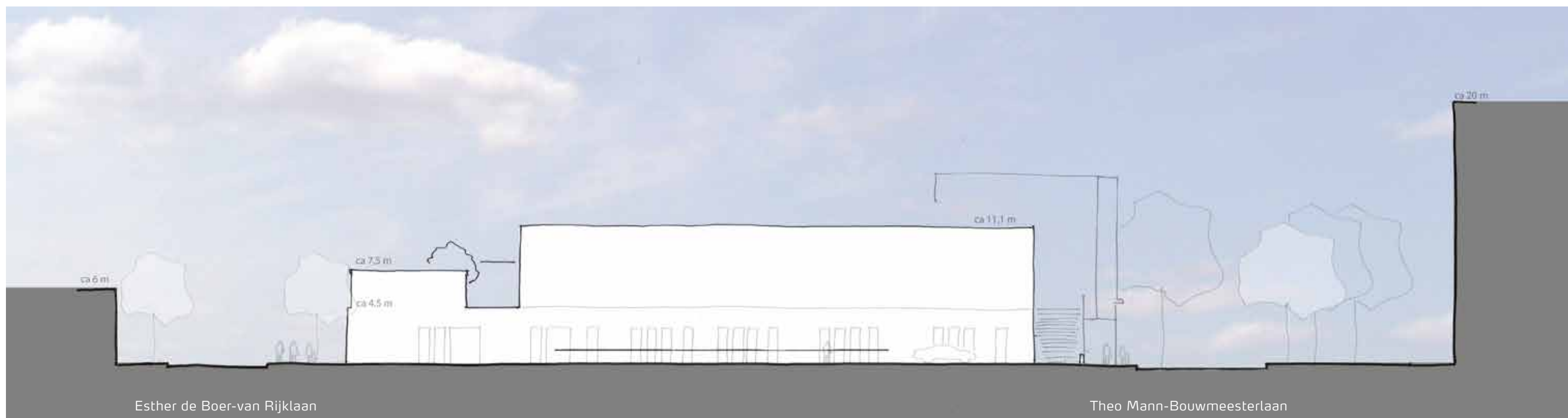

visie

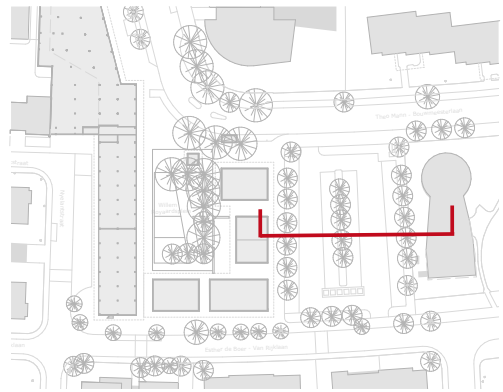

bestaand

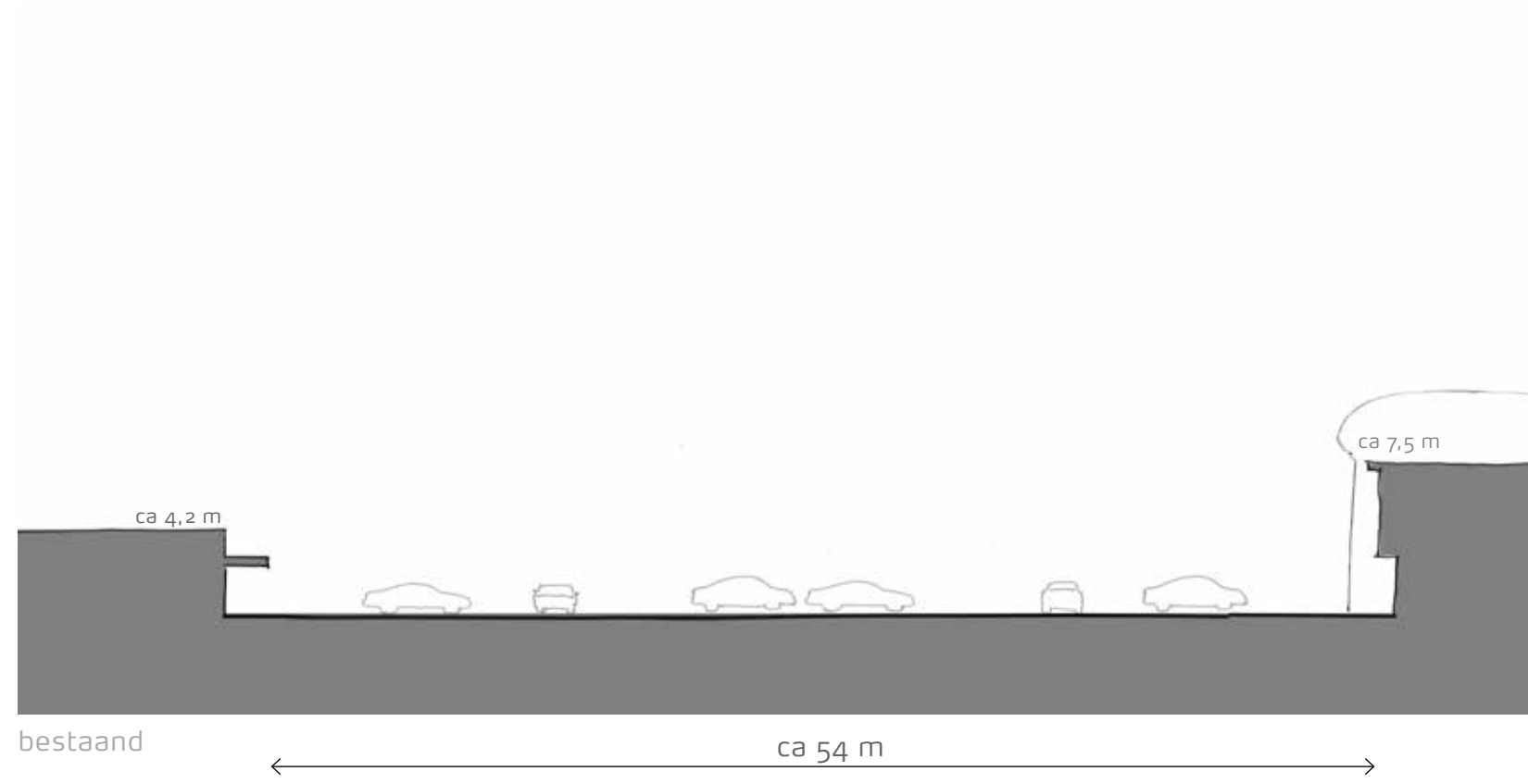

bestaand

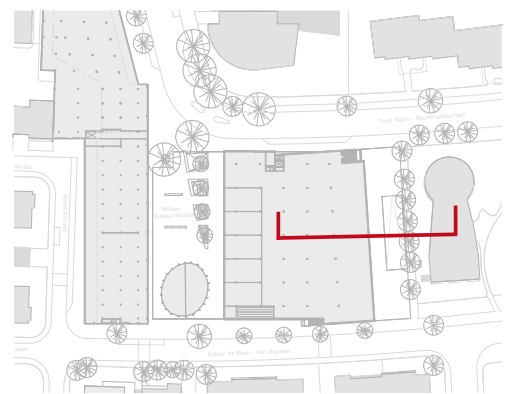

visie

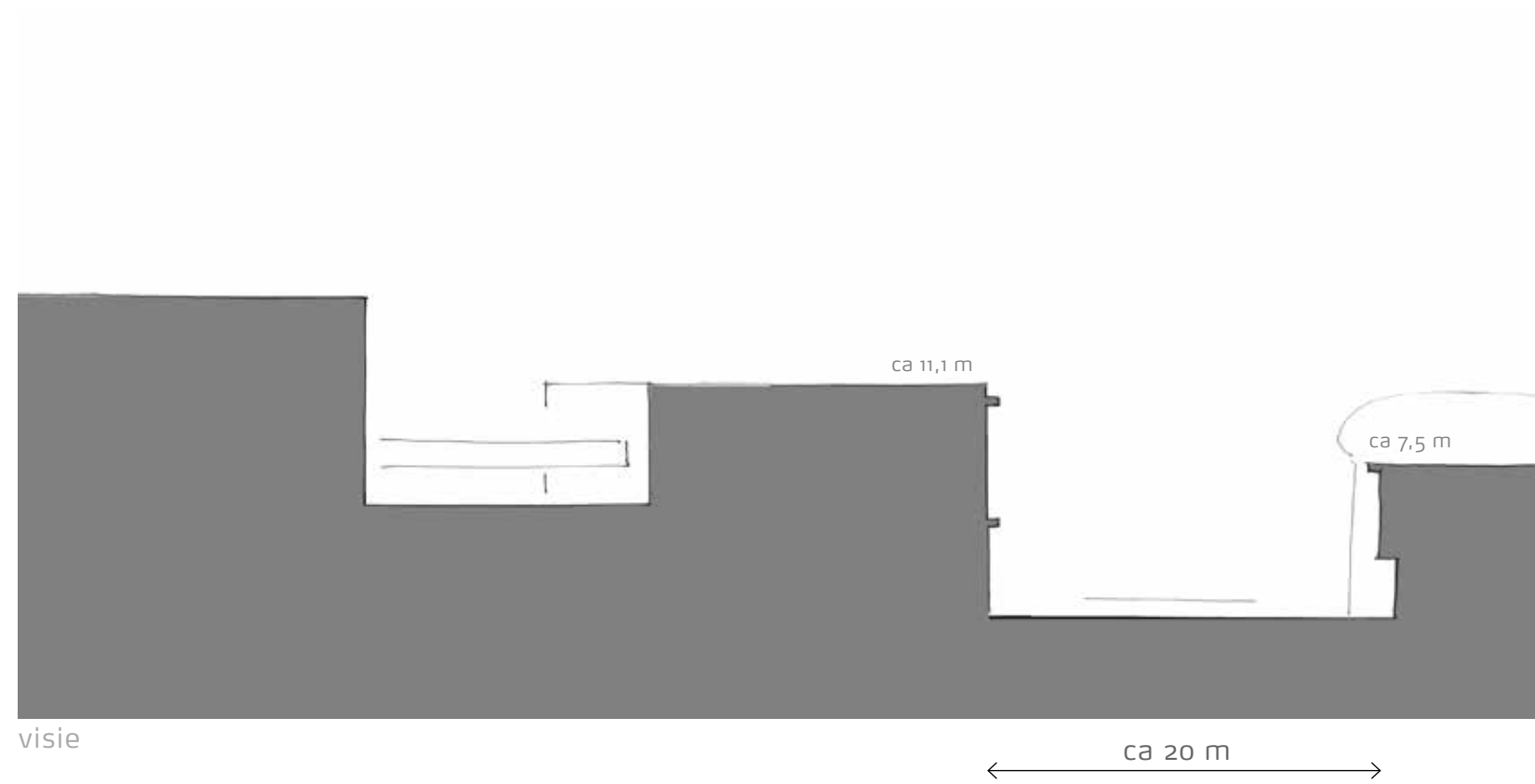

visie

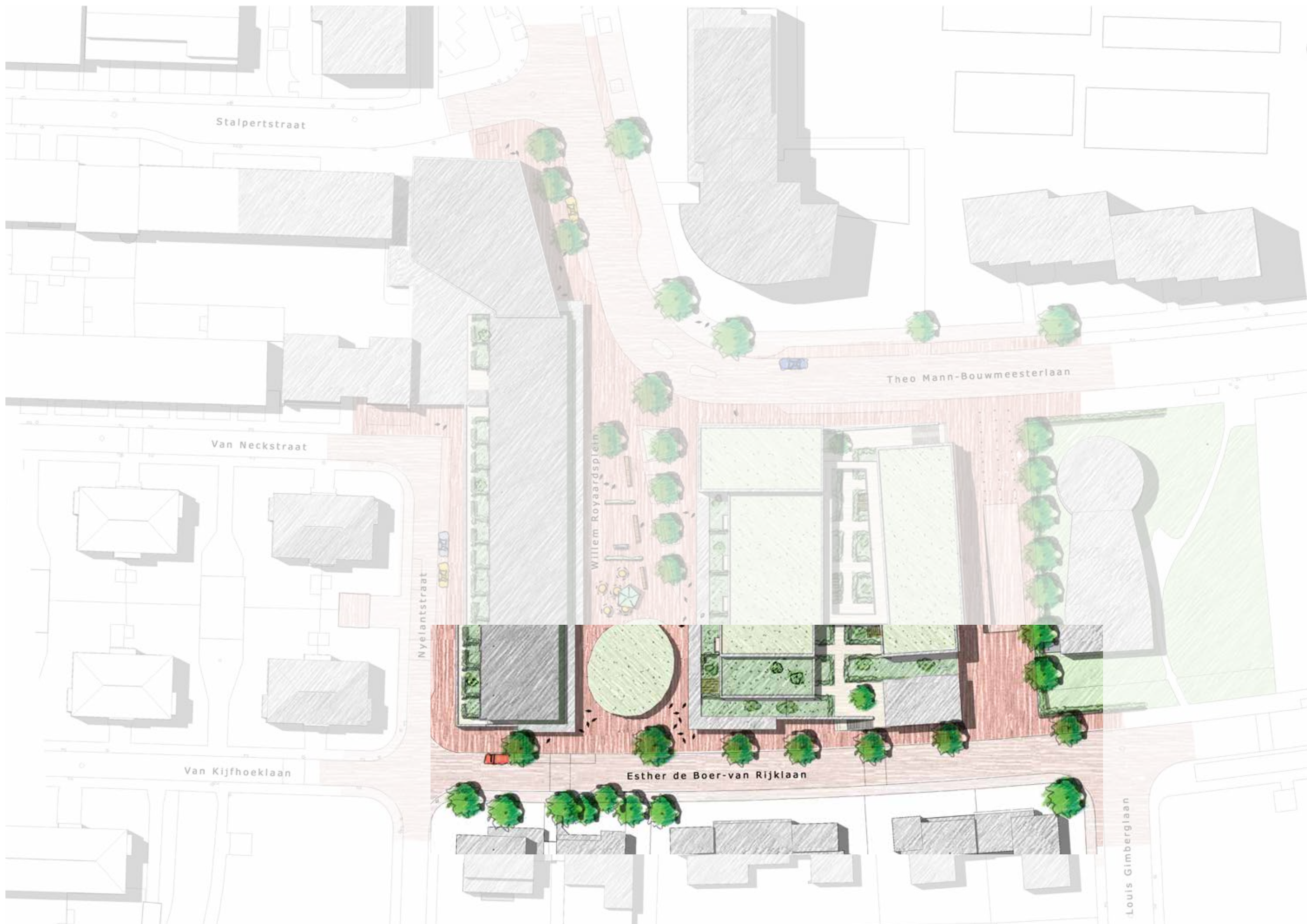



1 paviljoens en doorgangen naar het plein



2 paviljoens en parkeerterrein

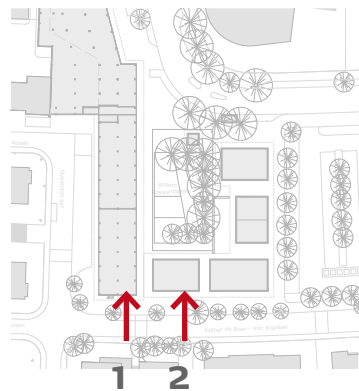

onderzoeksgedebied Esther de Boer-van Rijklaan

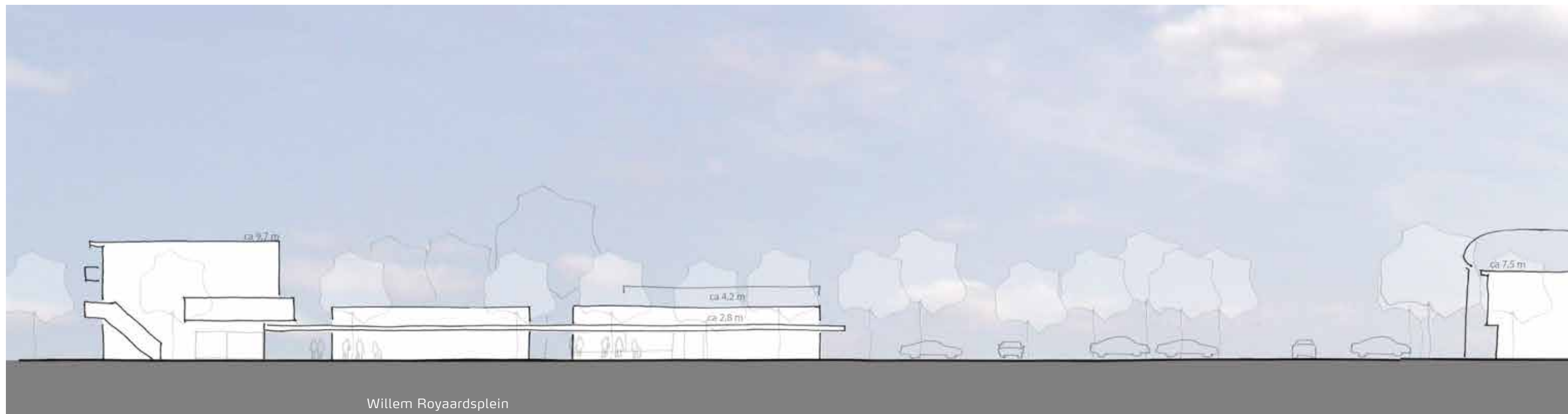

bestaand

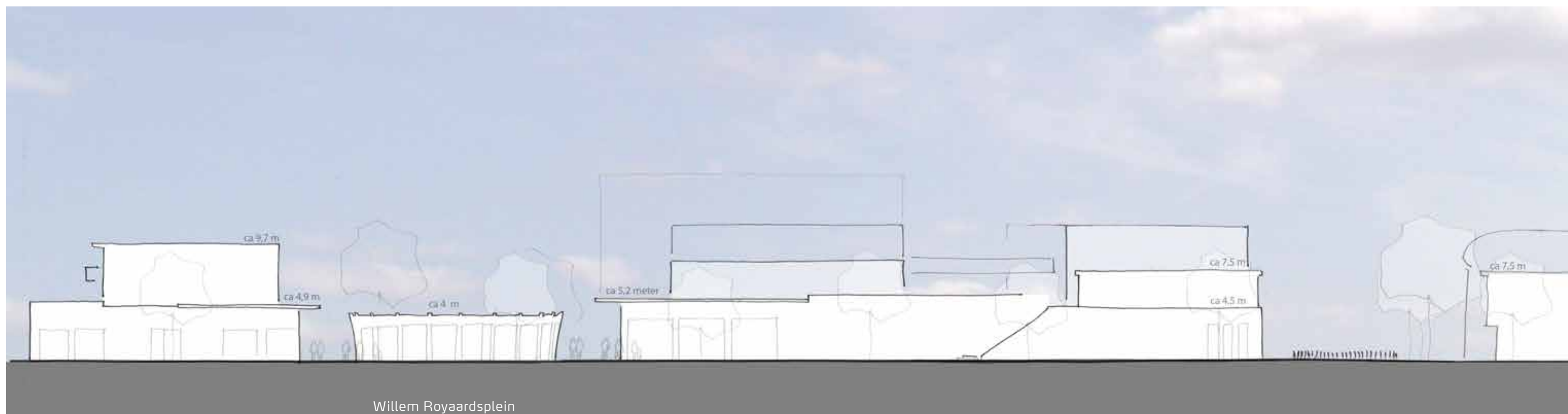

visie



bestaand 1 2

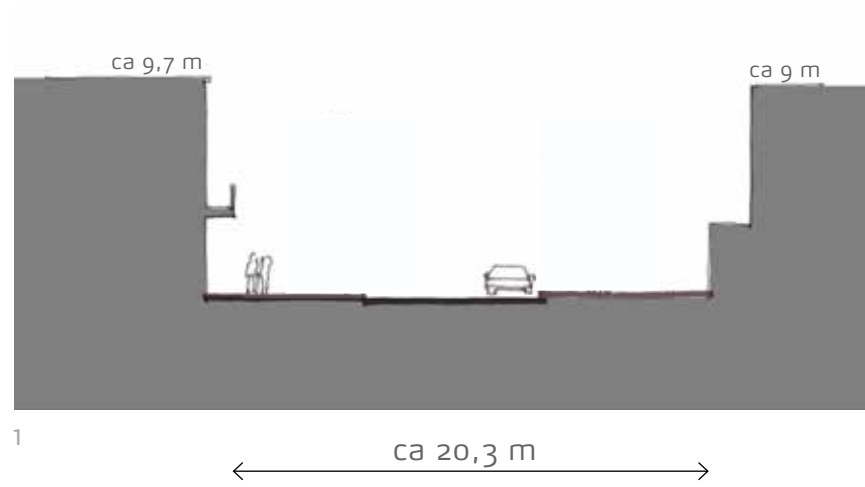

1

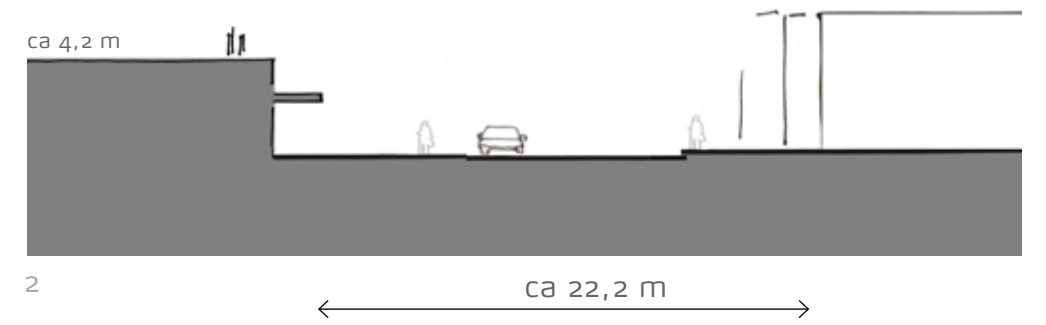

2

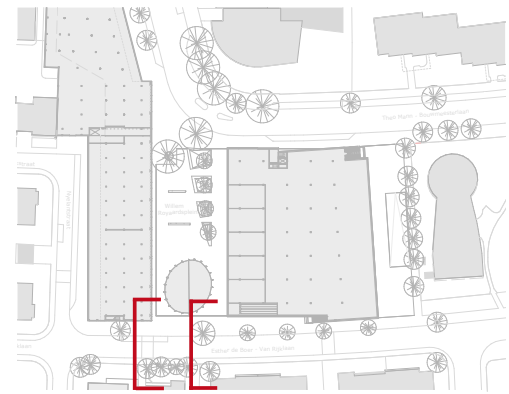

visie 1 2

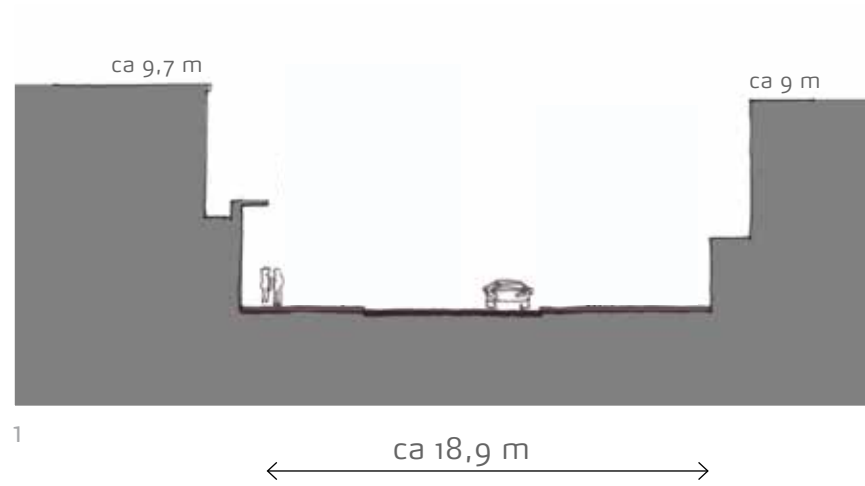

1

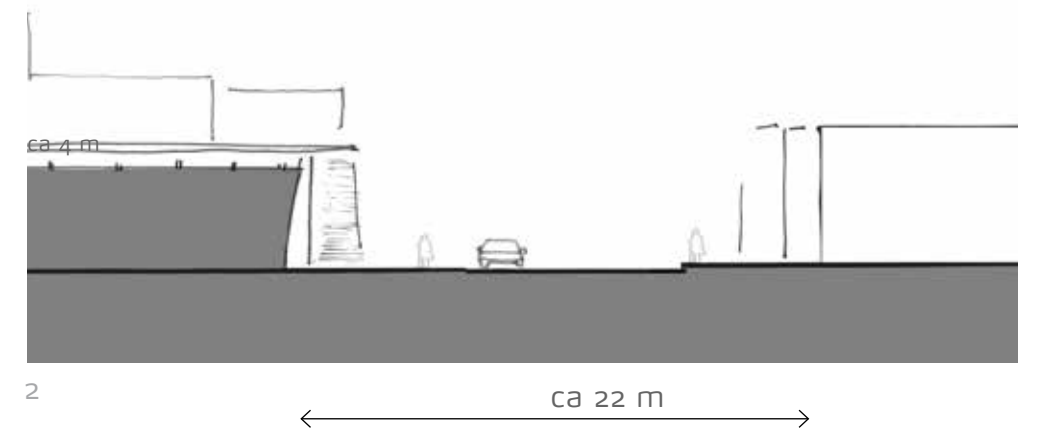

2



bestaand 3 4

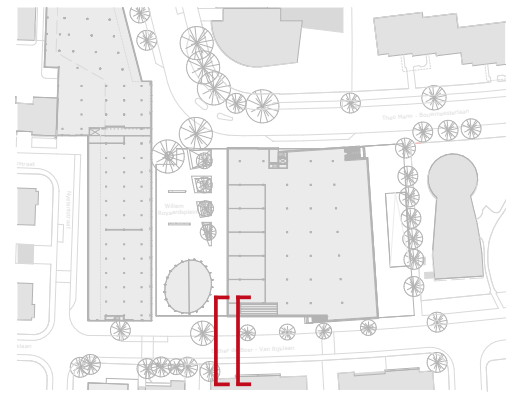
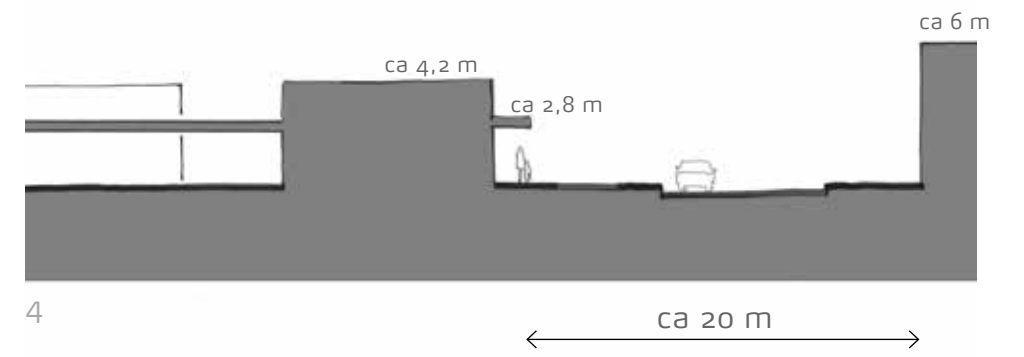
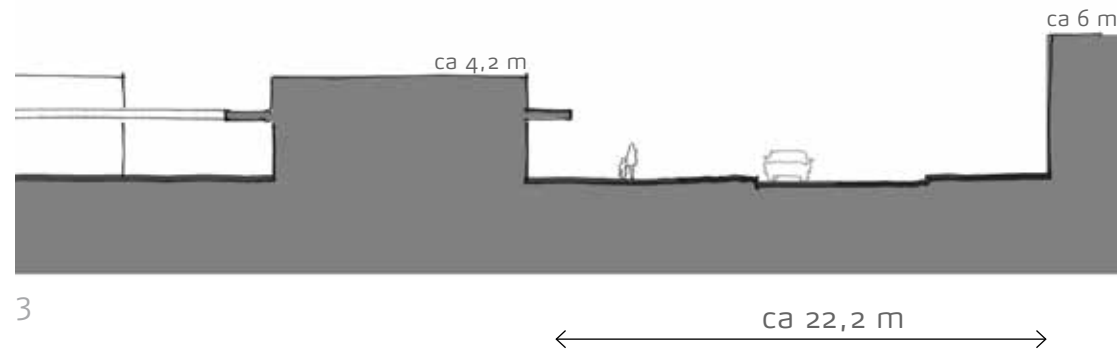

visie 3 4

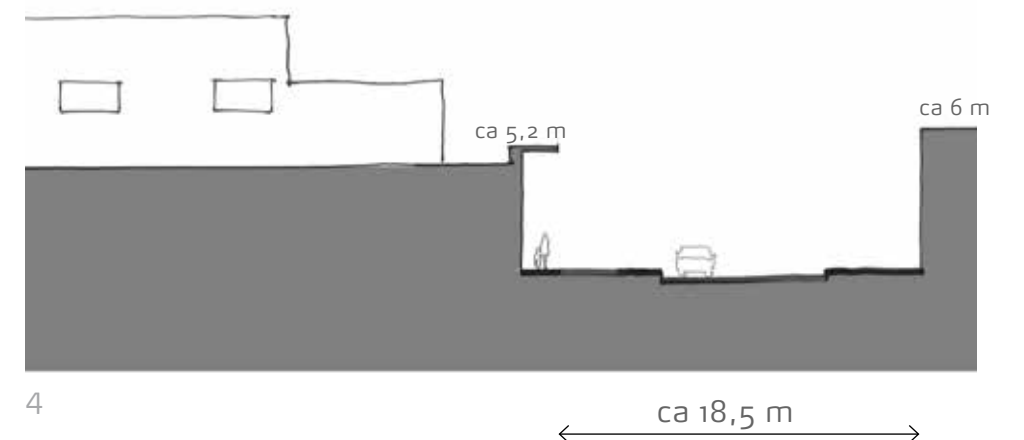
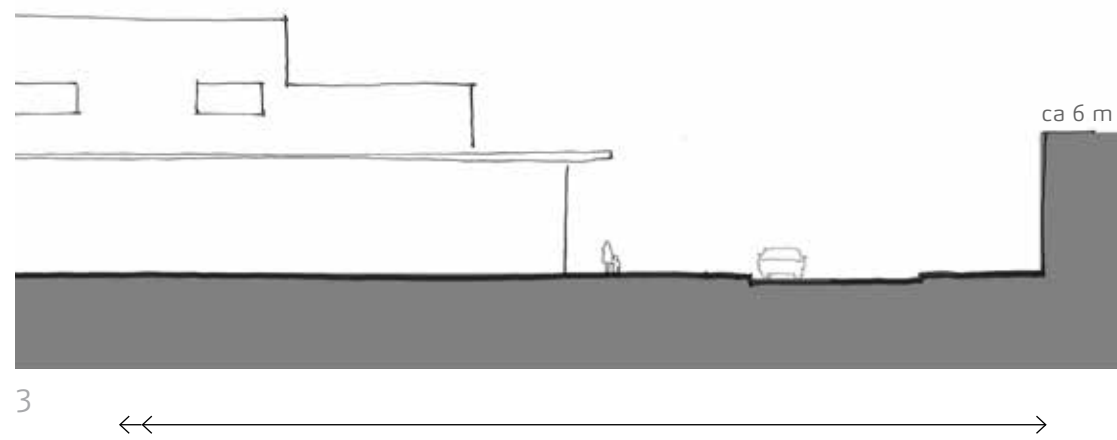

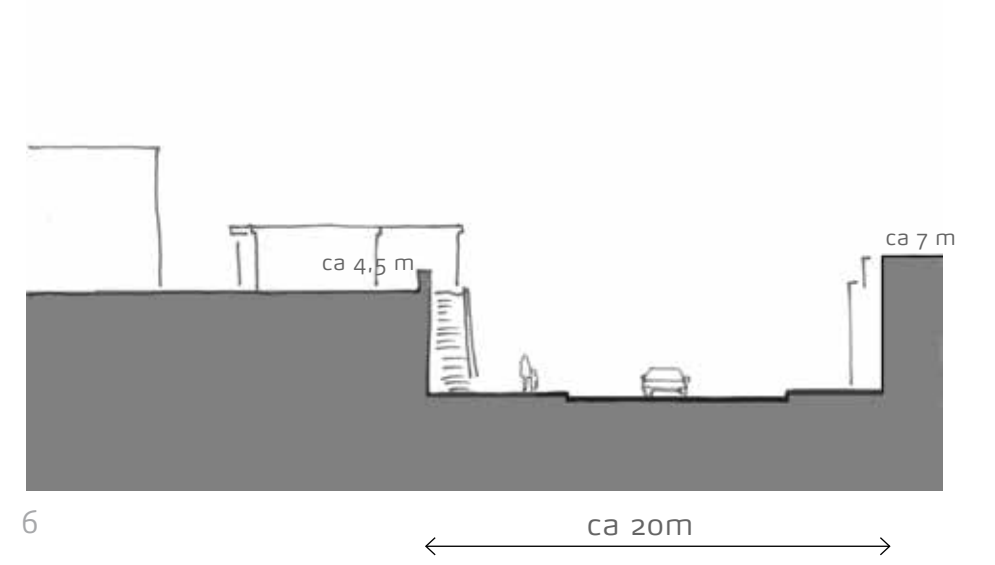
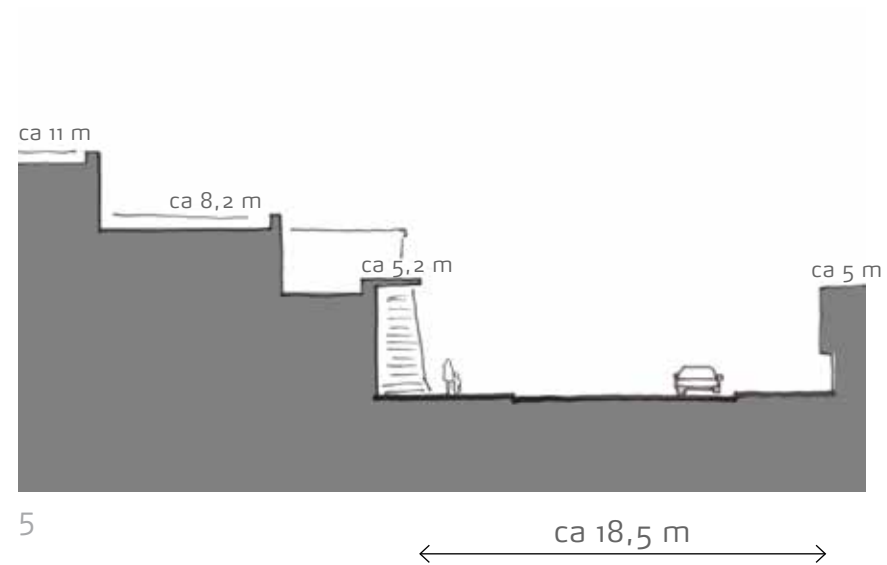
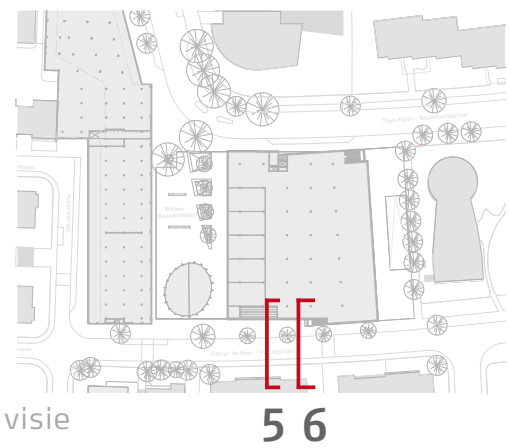
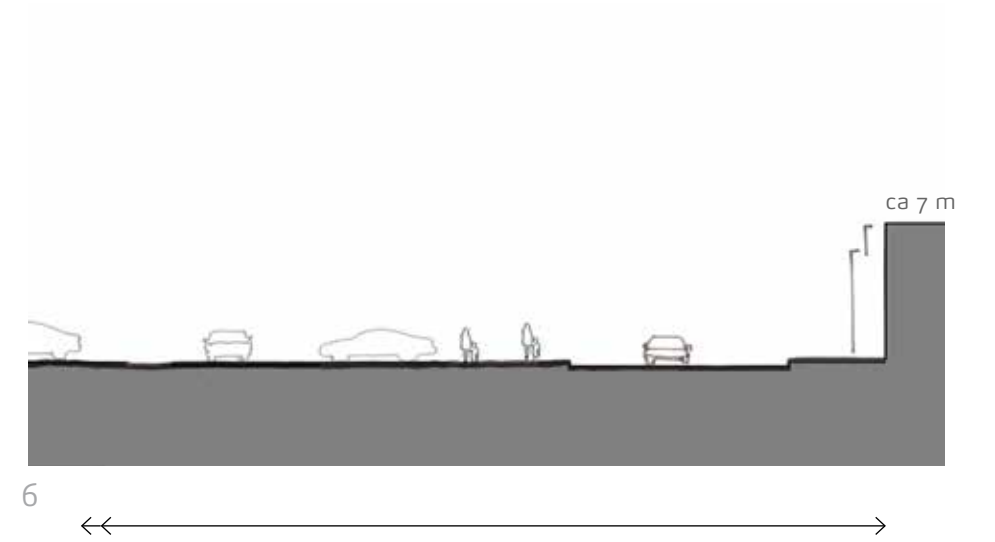
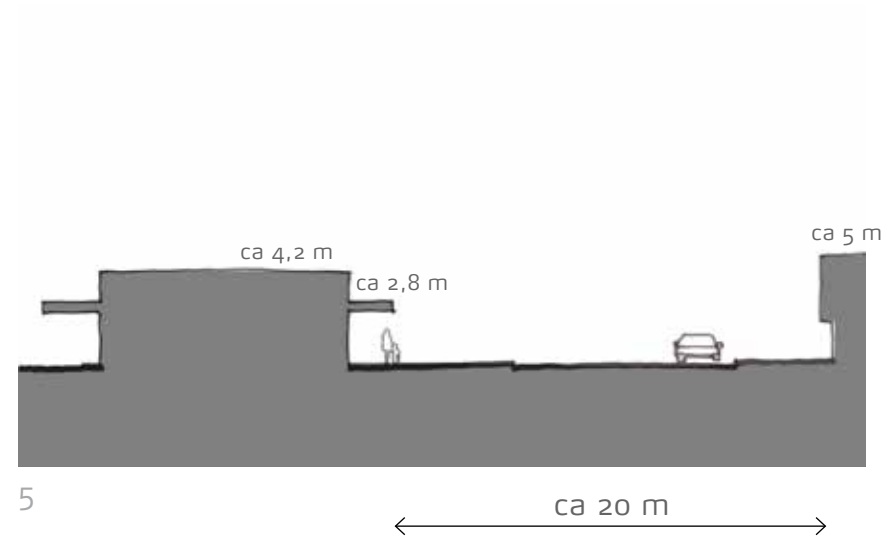
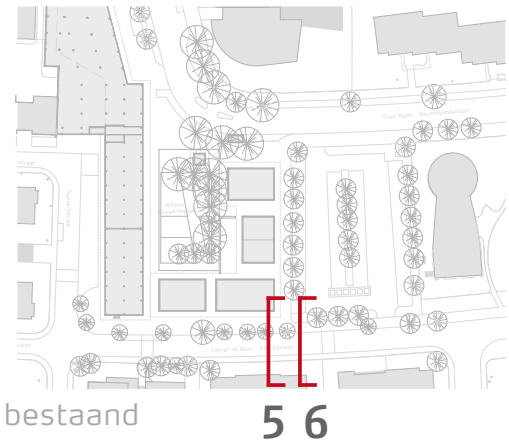

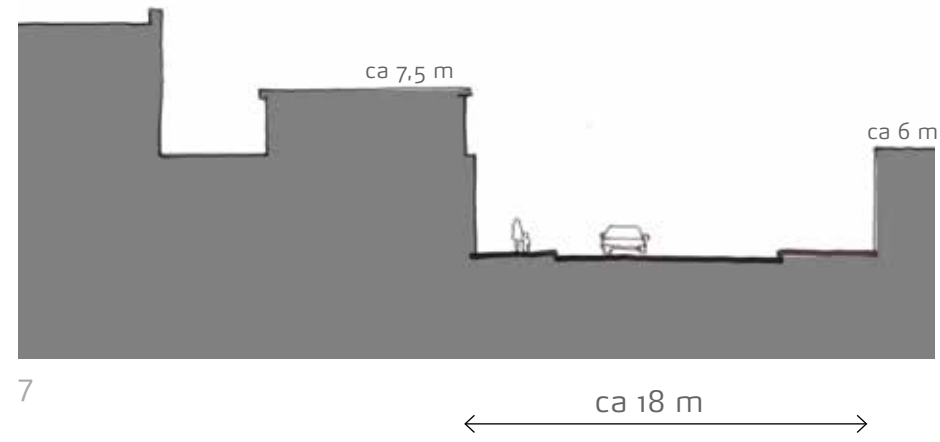
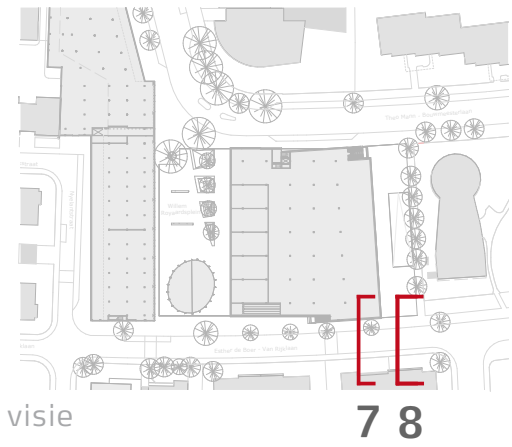
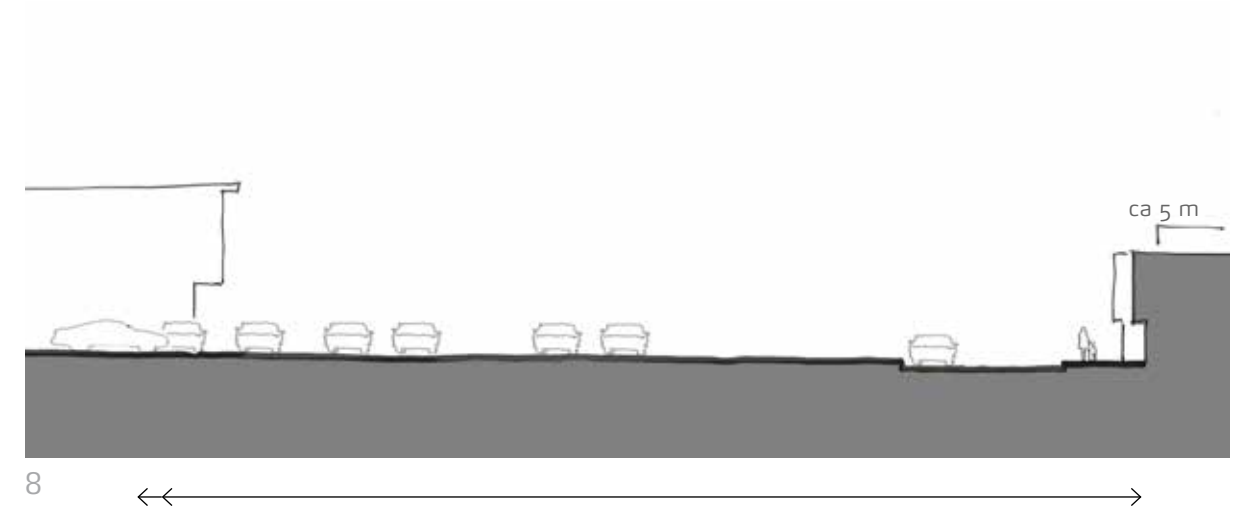
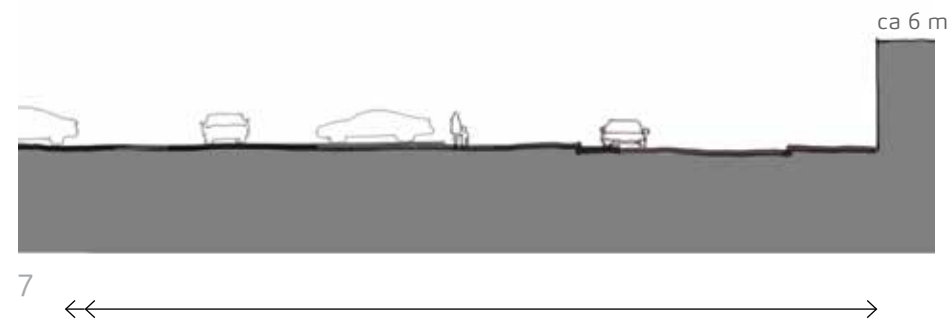
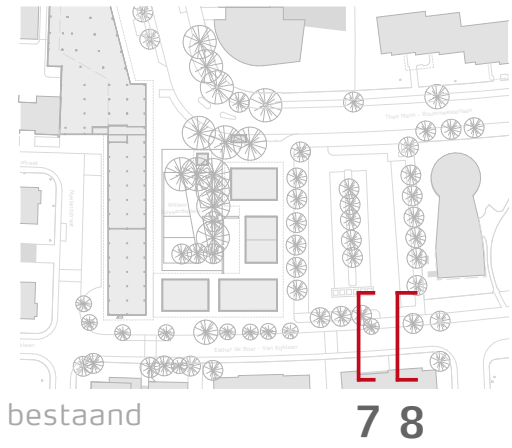

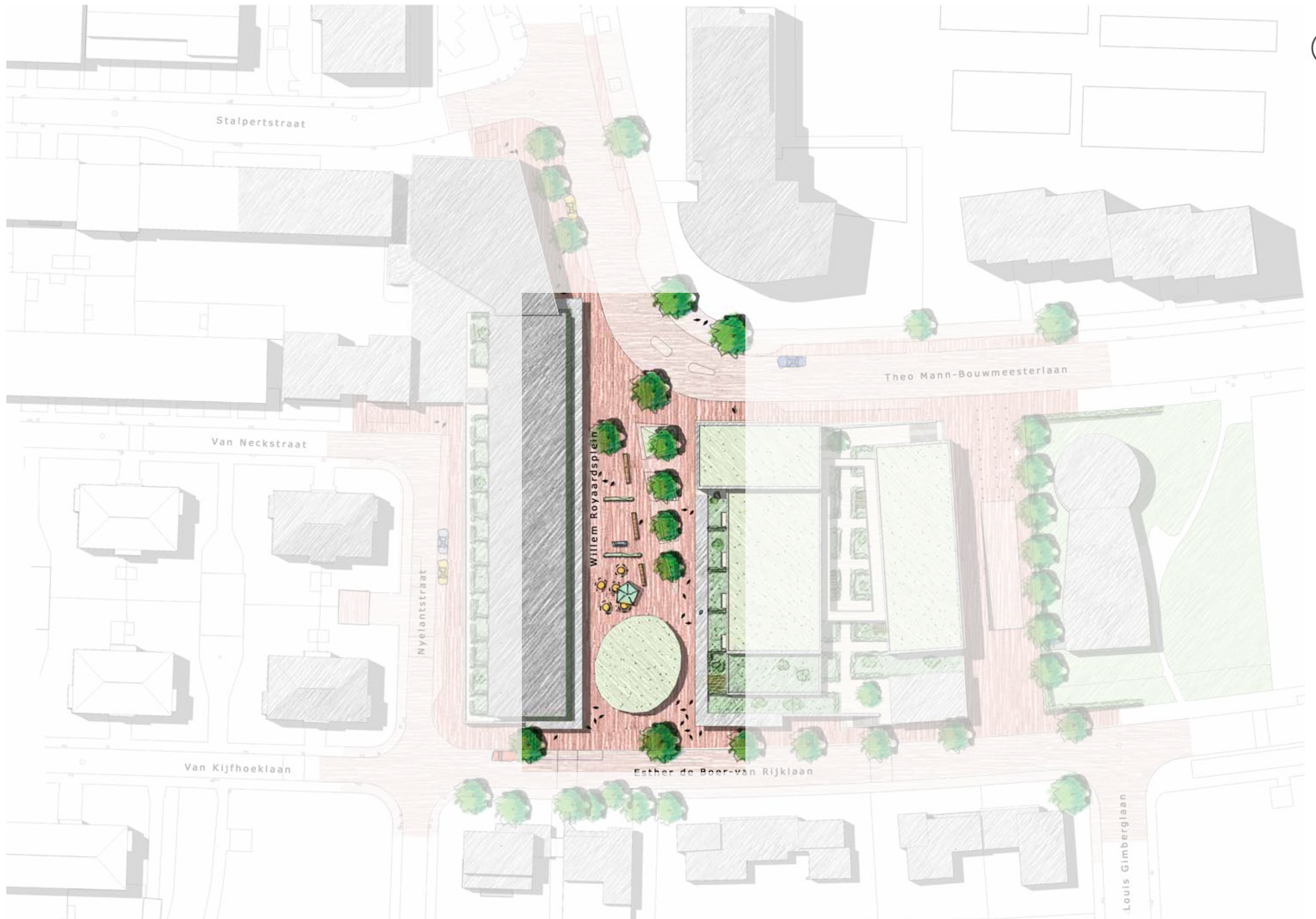



1 Willem Royaardsplein vanuit balkon niveau 1



2 Willem Royaardsplein vanuit balkon niveau 2

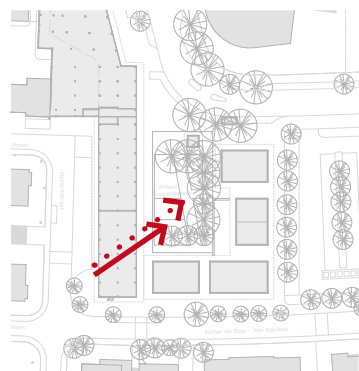

onderzoeksgebied Willem Royaardsplein



bestaand

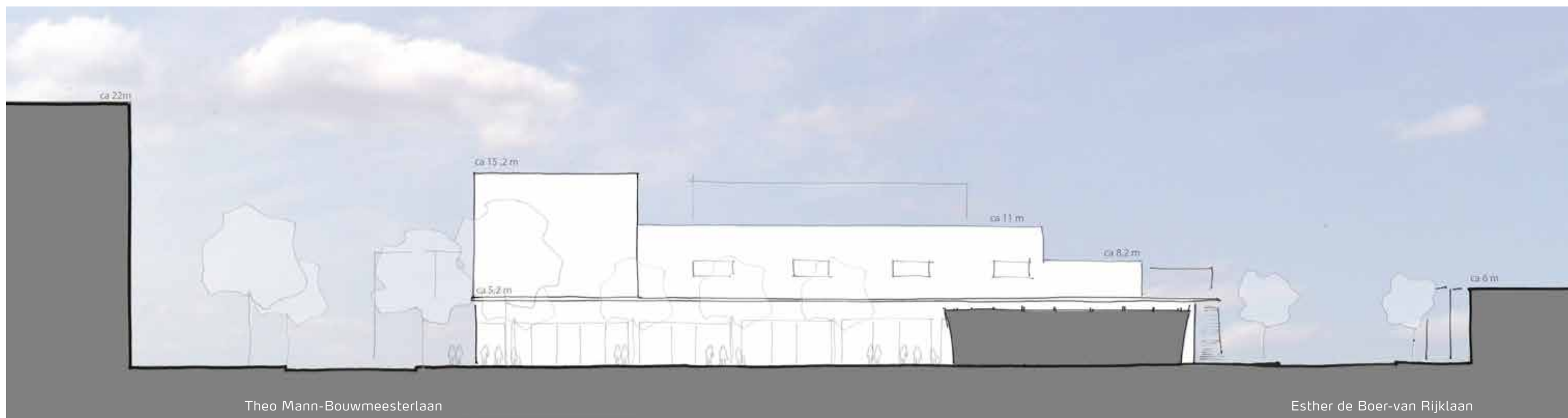

visie

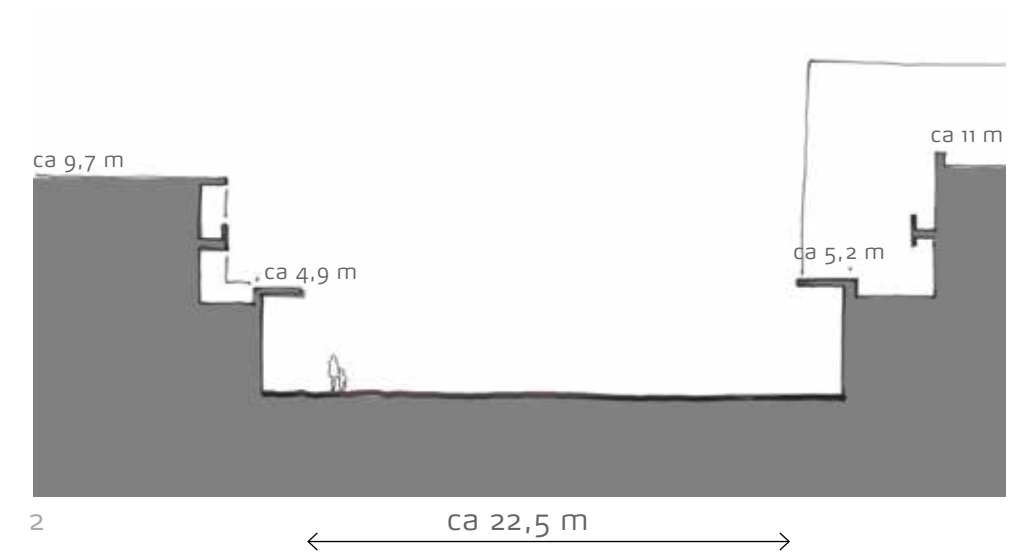
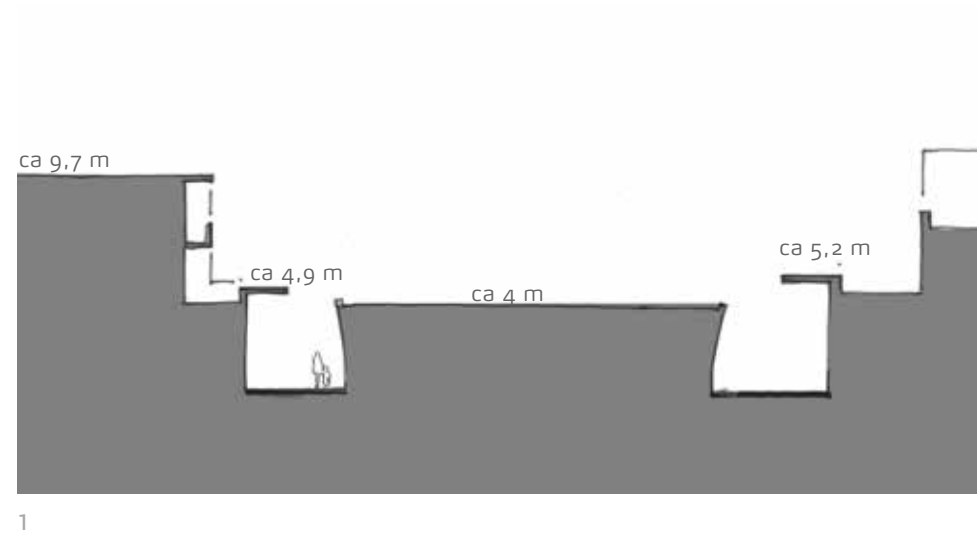
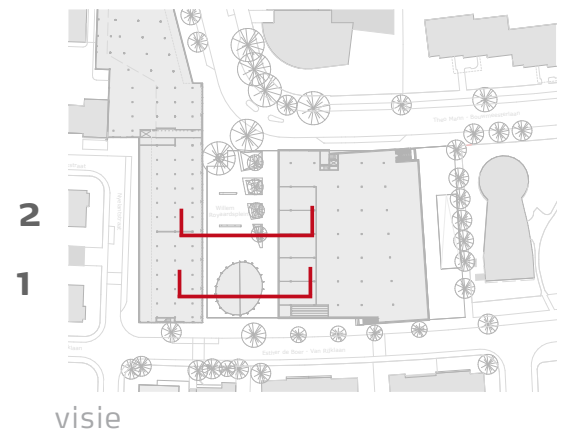
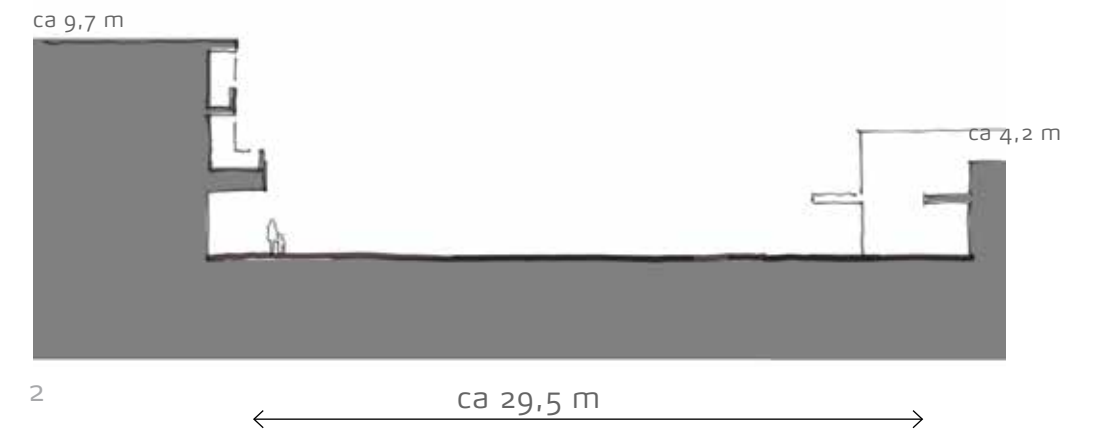
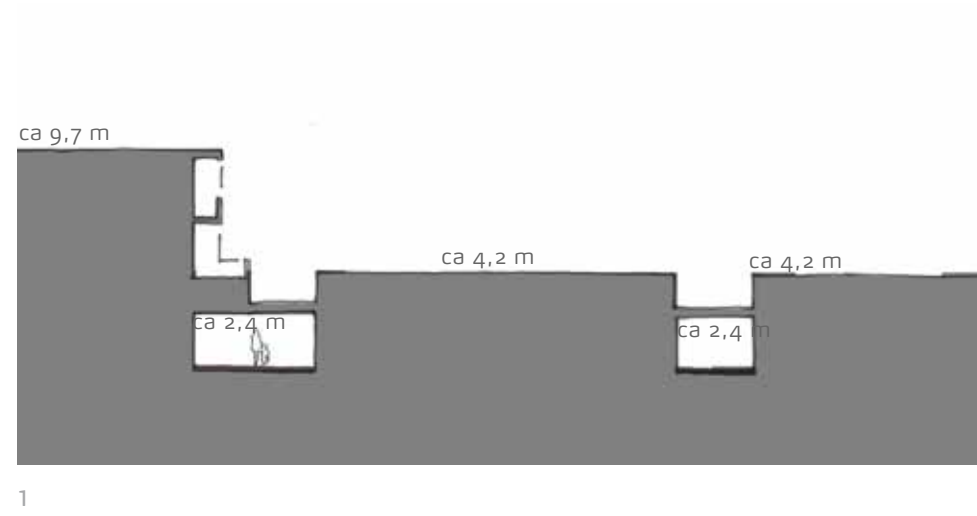
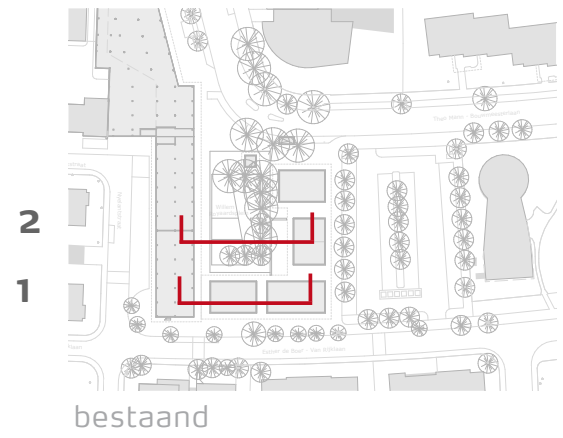

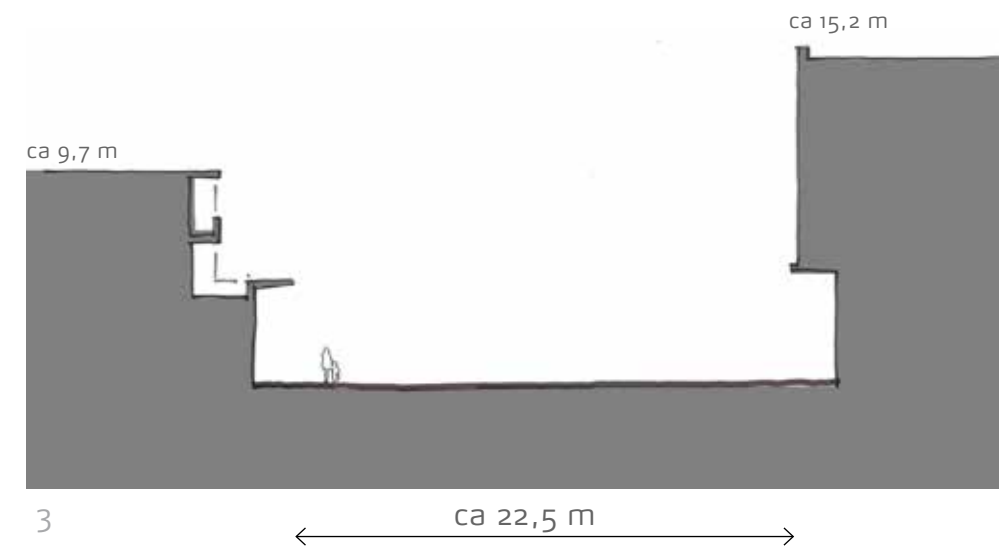
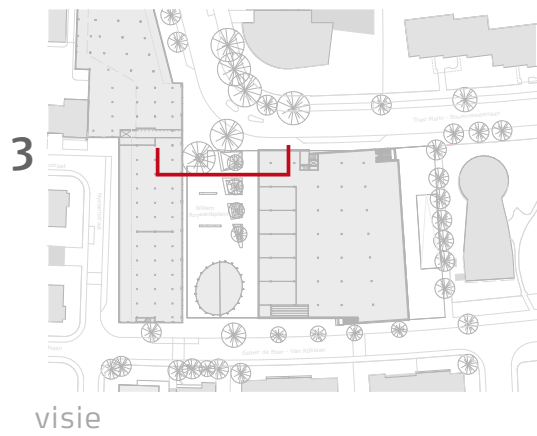
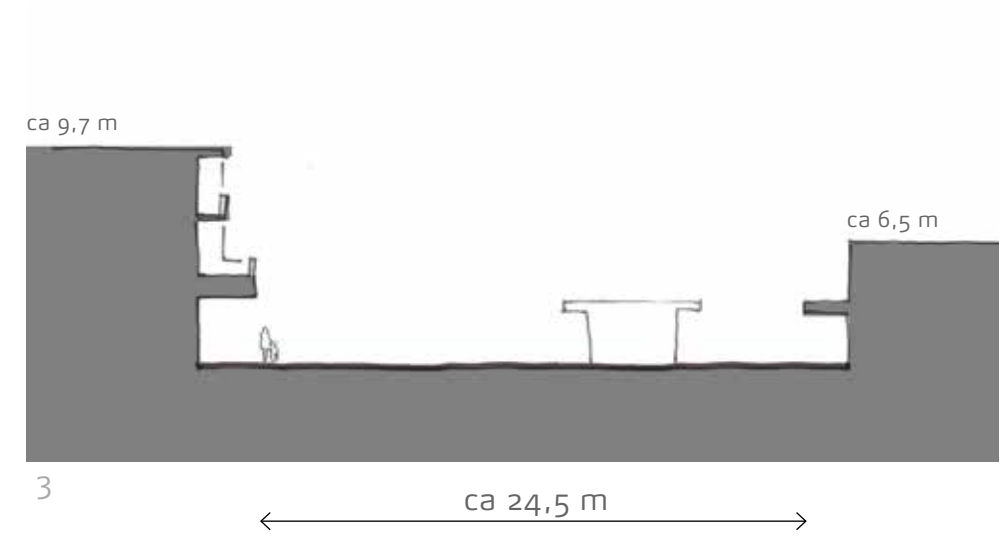

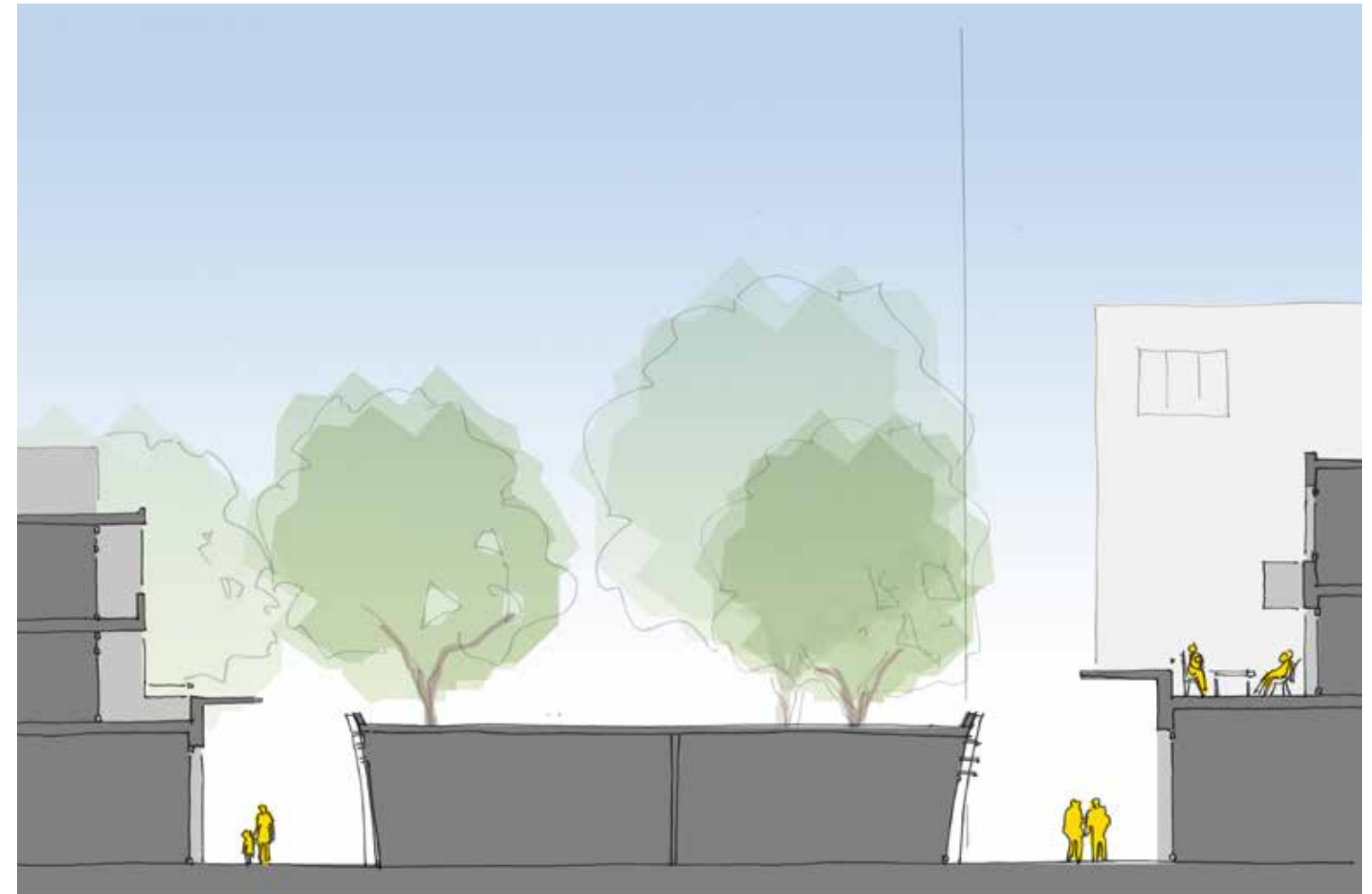
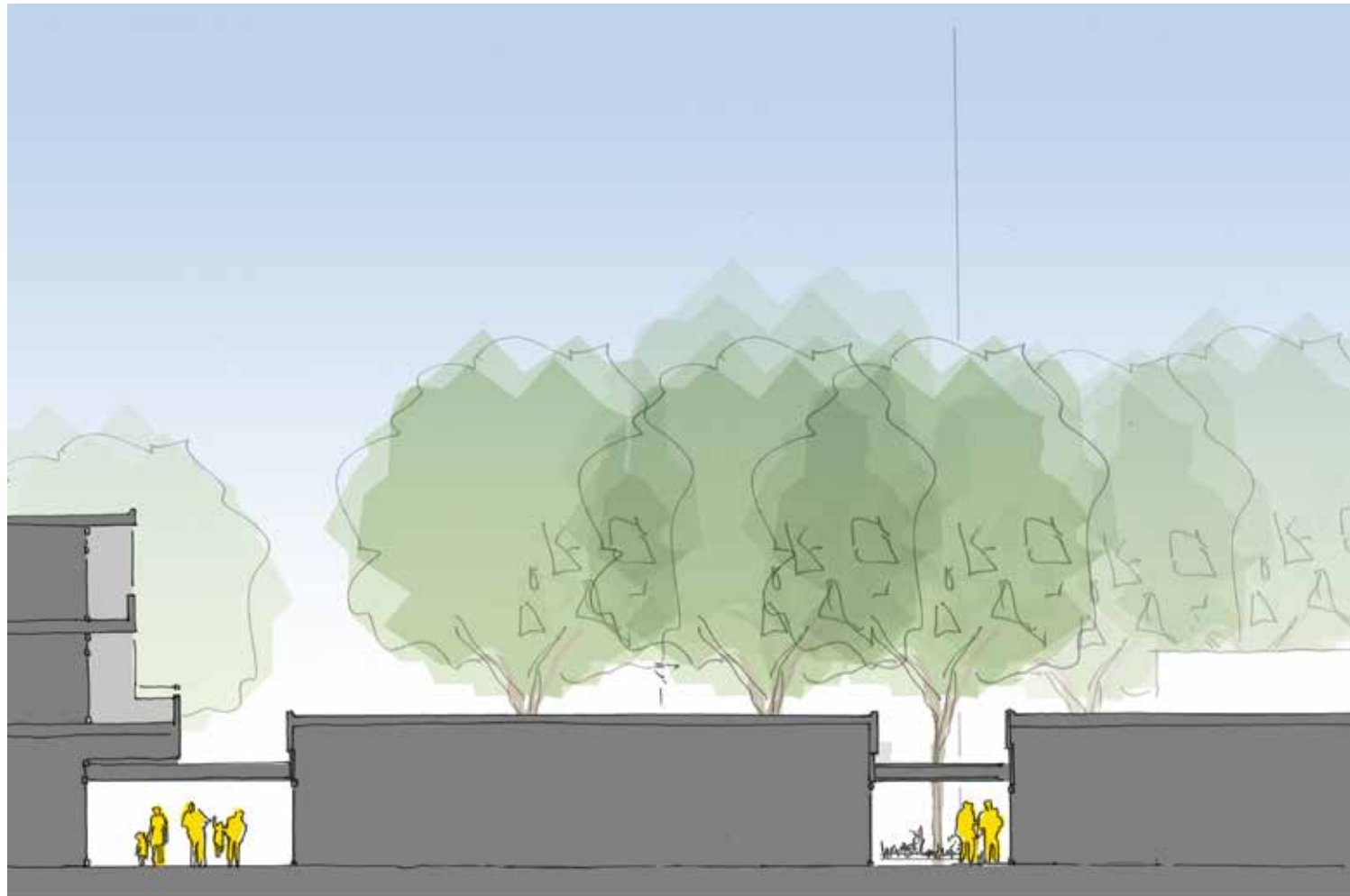

bestaand

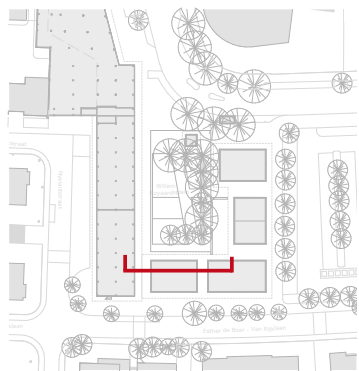

visie

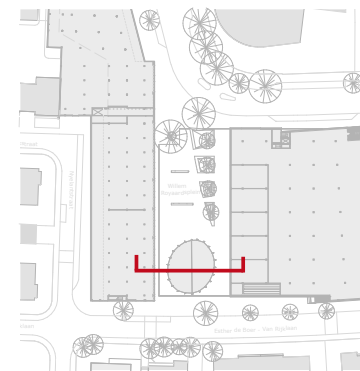

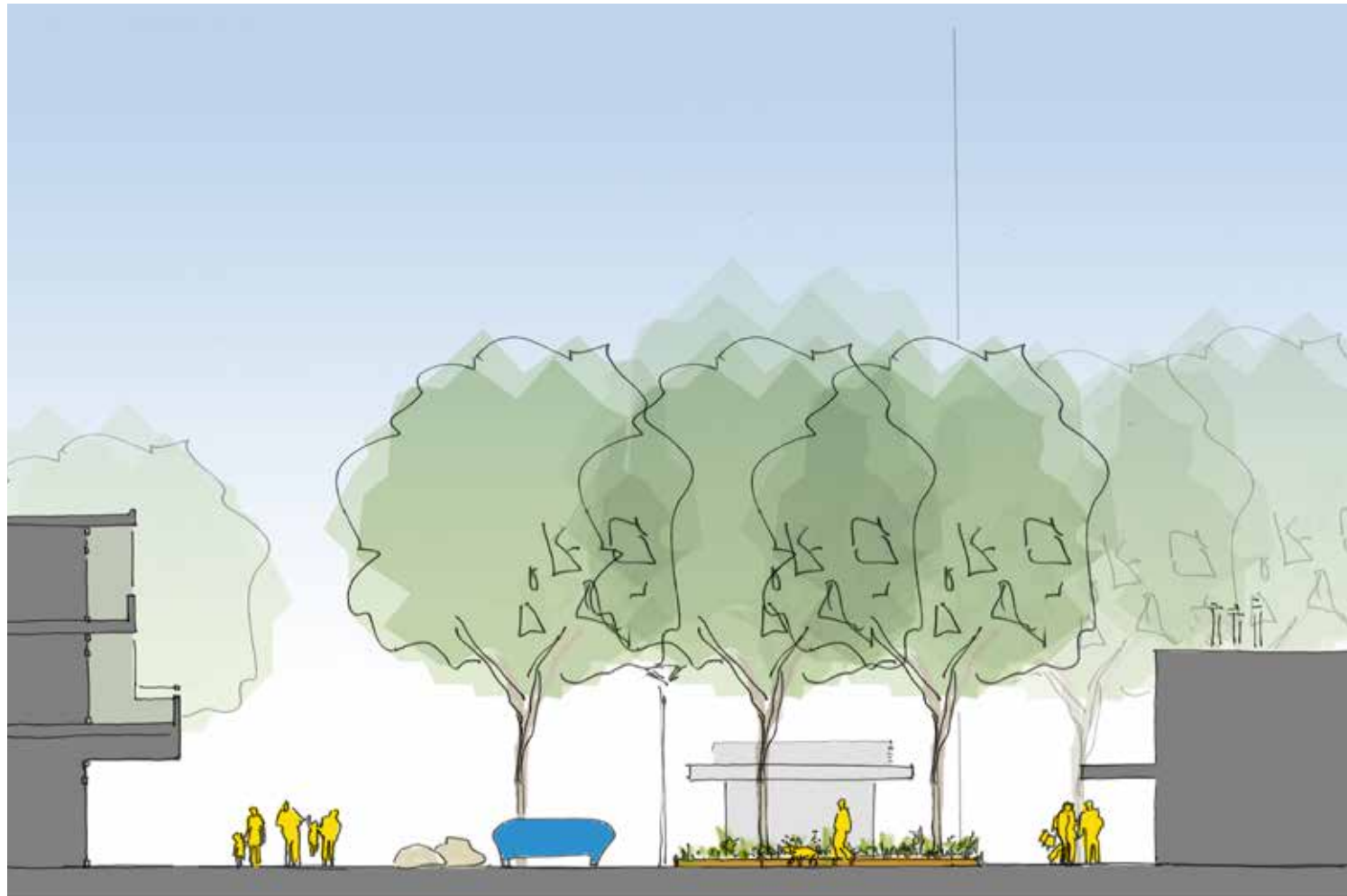

ca. 24,5 meter tussen luifels

ca. 29 meter tussen puilen



ca. 22,5 meter tussen luifels

ca. 26,4 meter tussen puilen

bestaand

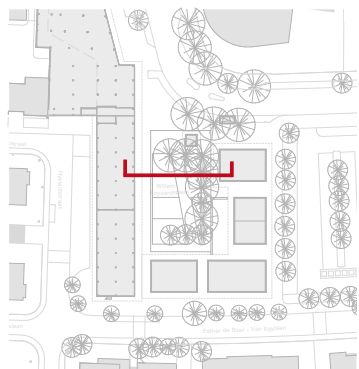

visie

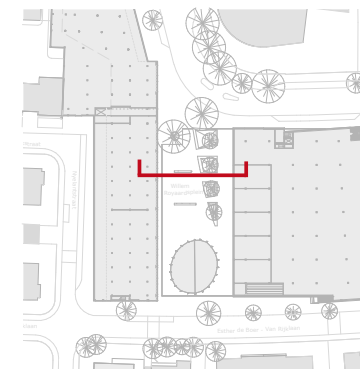



uitzicht balkon niveau 1

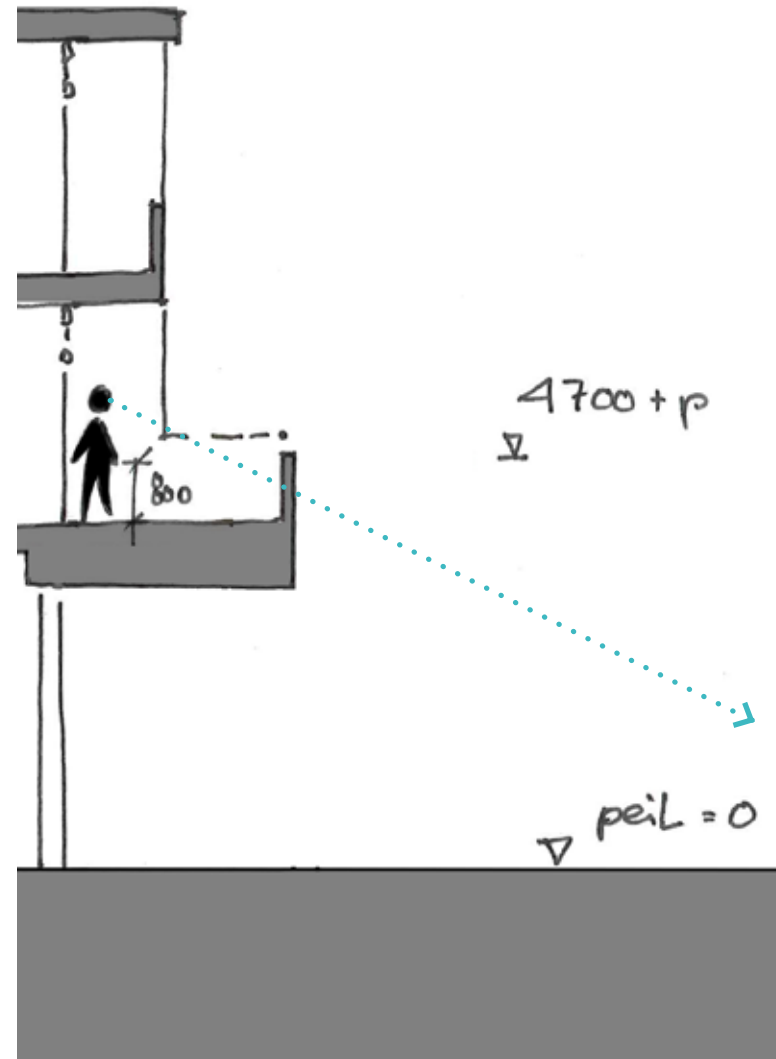

bestaande bebouwing



plein aanzicht

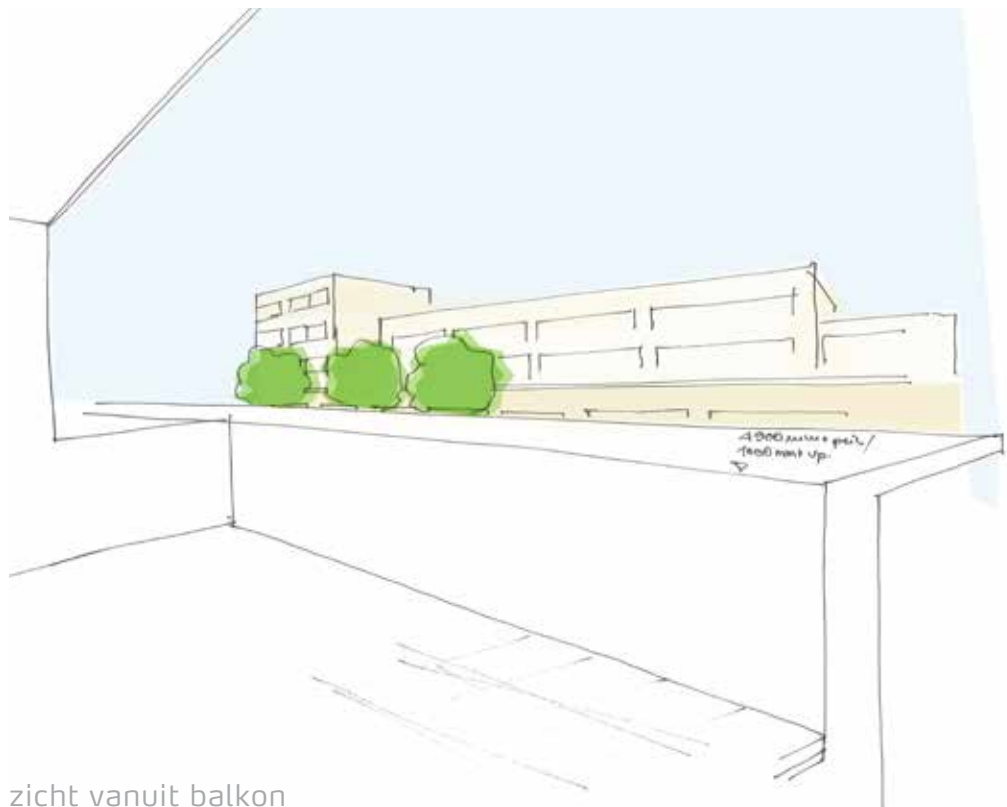

zicht vanuit balkon

onderzoek luifel | visie

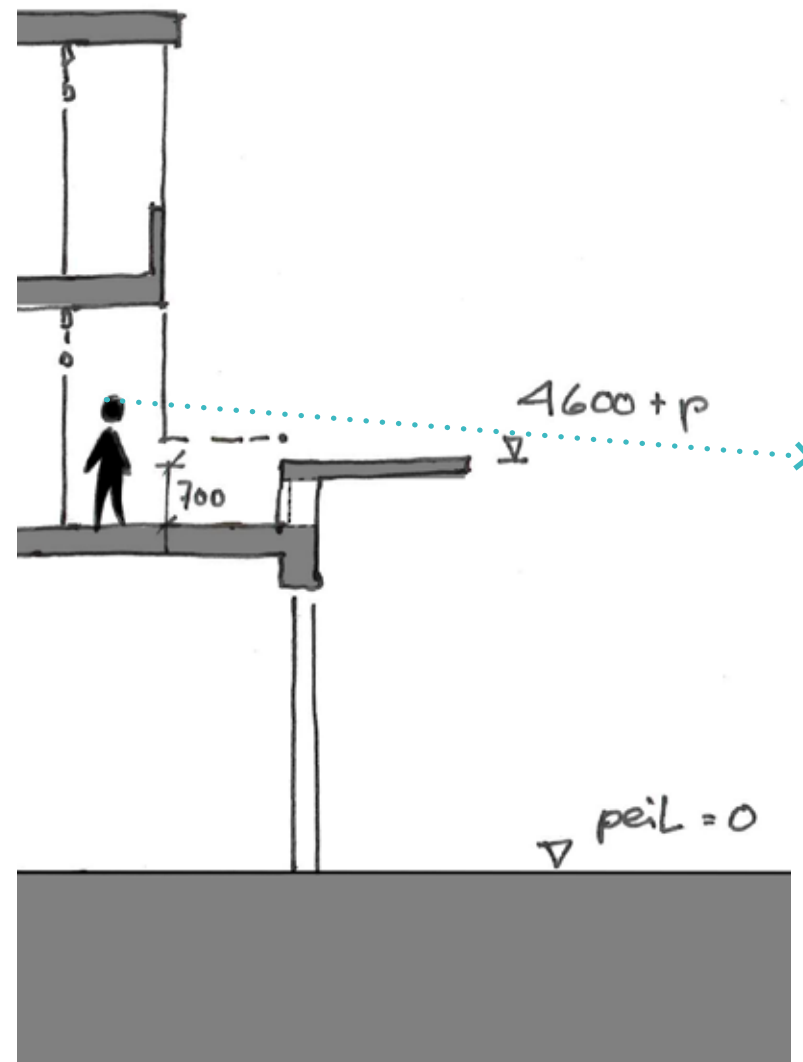

bestaande bebouwing

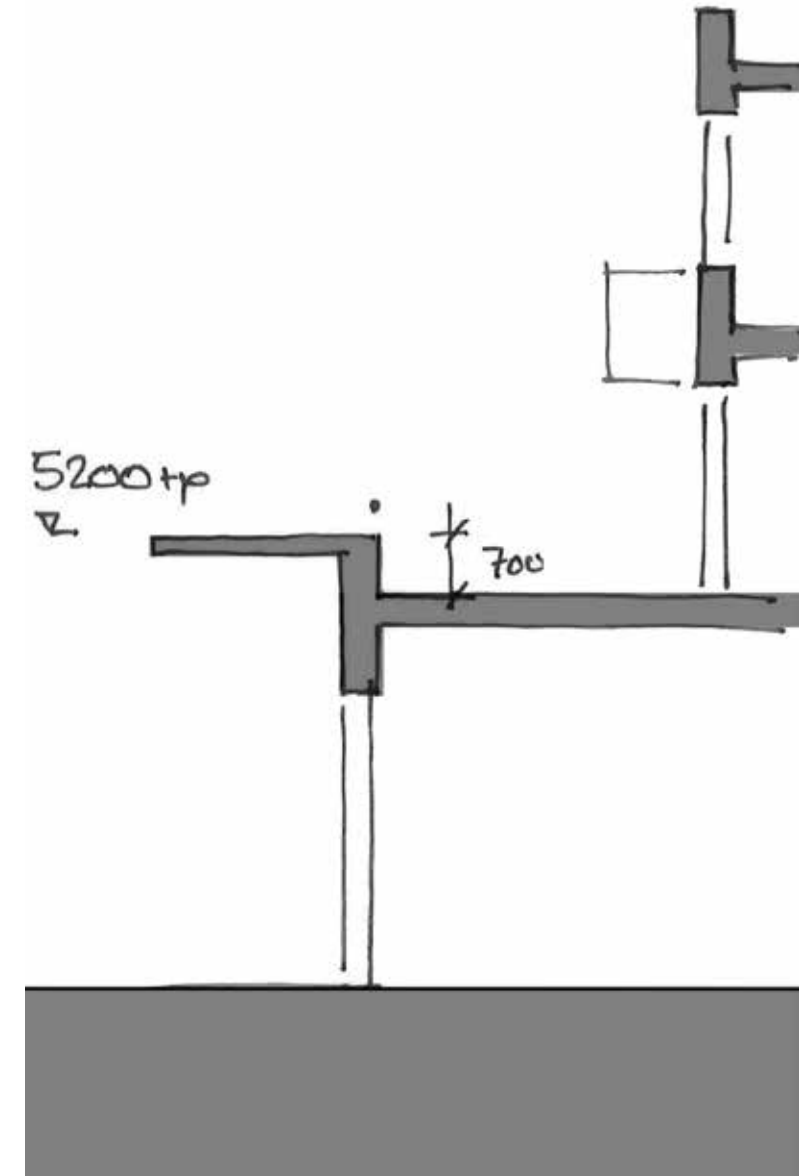

nieuwbouw

Den Haag | Duinzigt



plein aanzicht

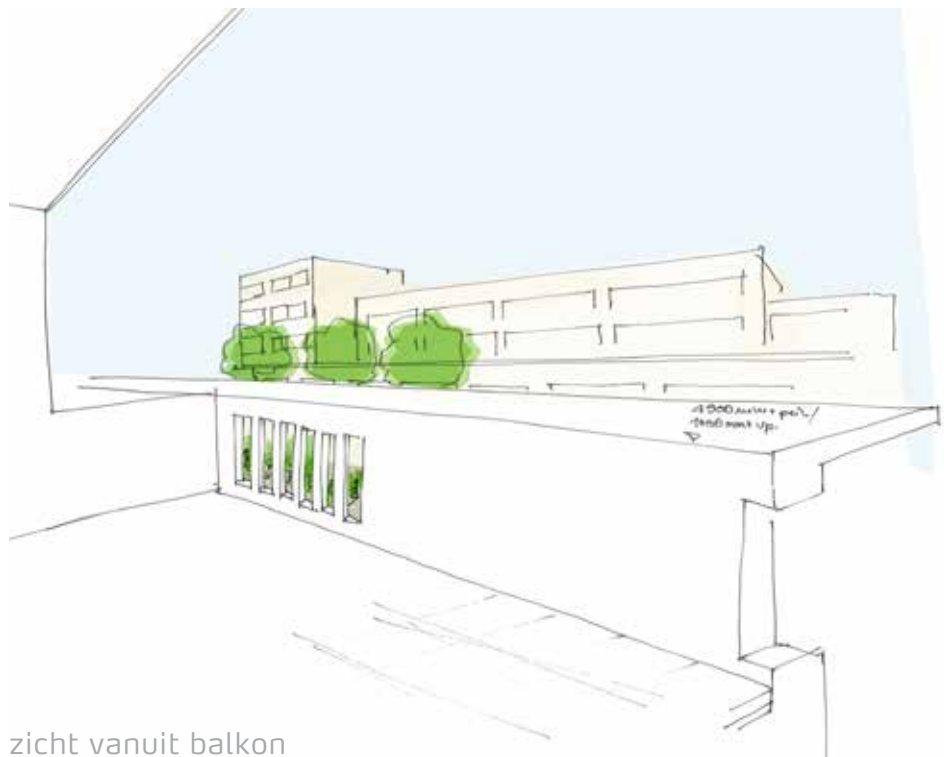

zicht vanuit balkon

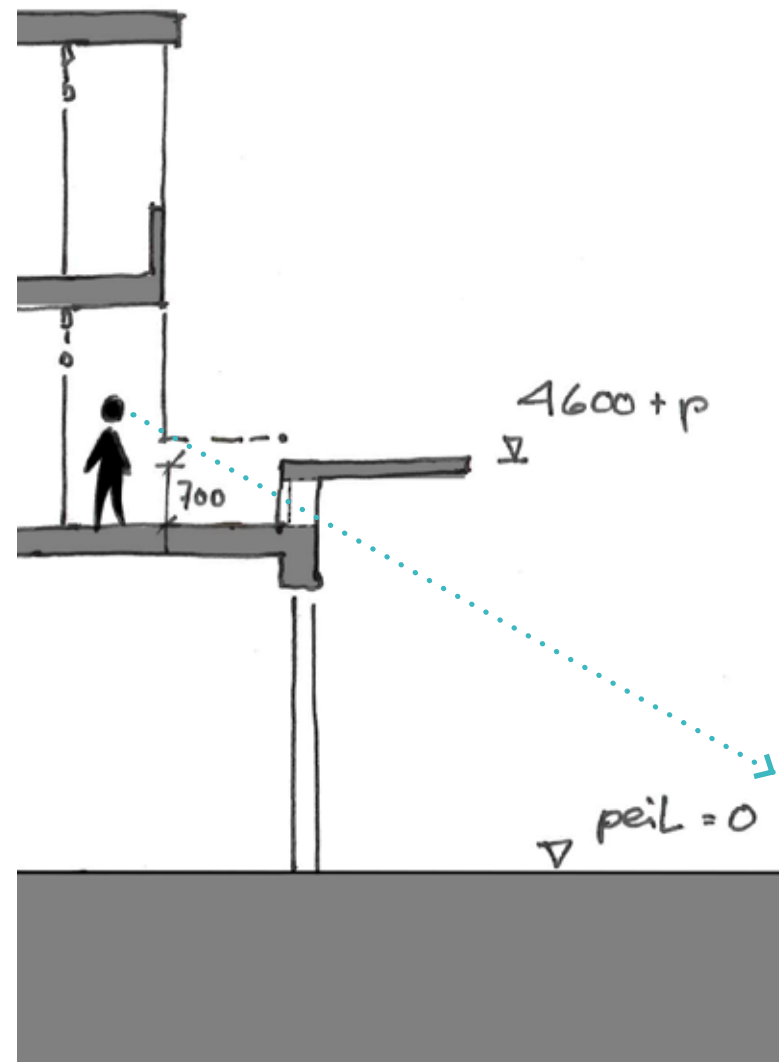

bestaande bebouwing

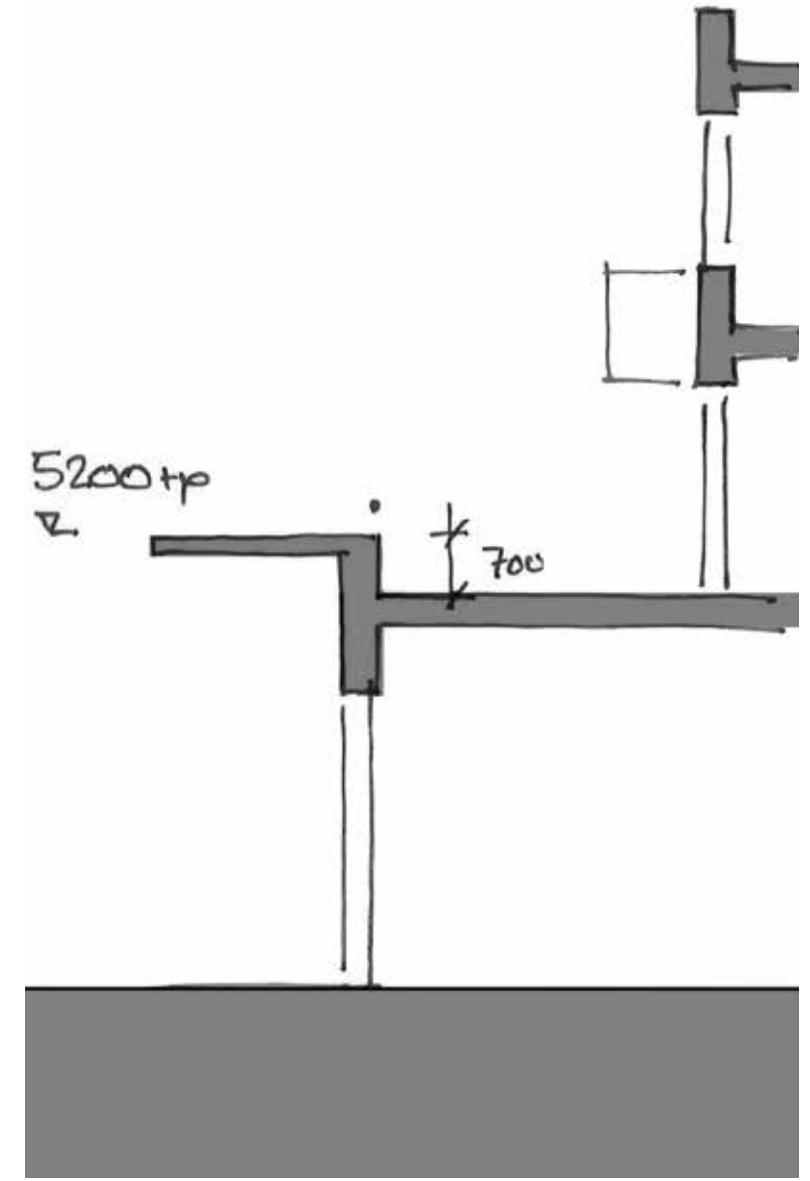

nieuwbouw



plein aanzicht

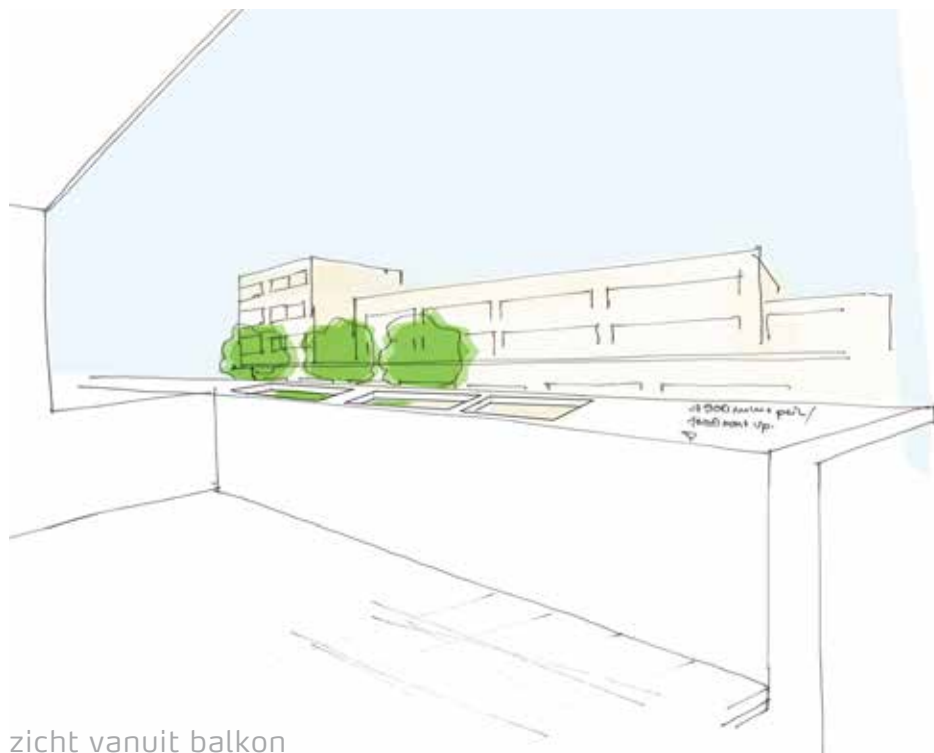

zicht vanuit balkon

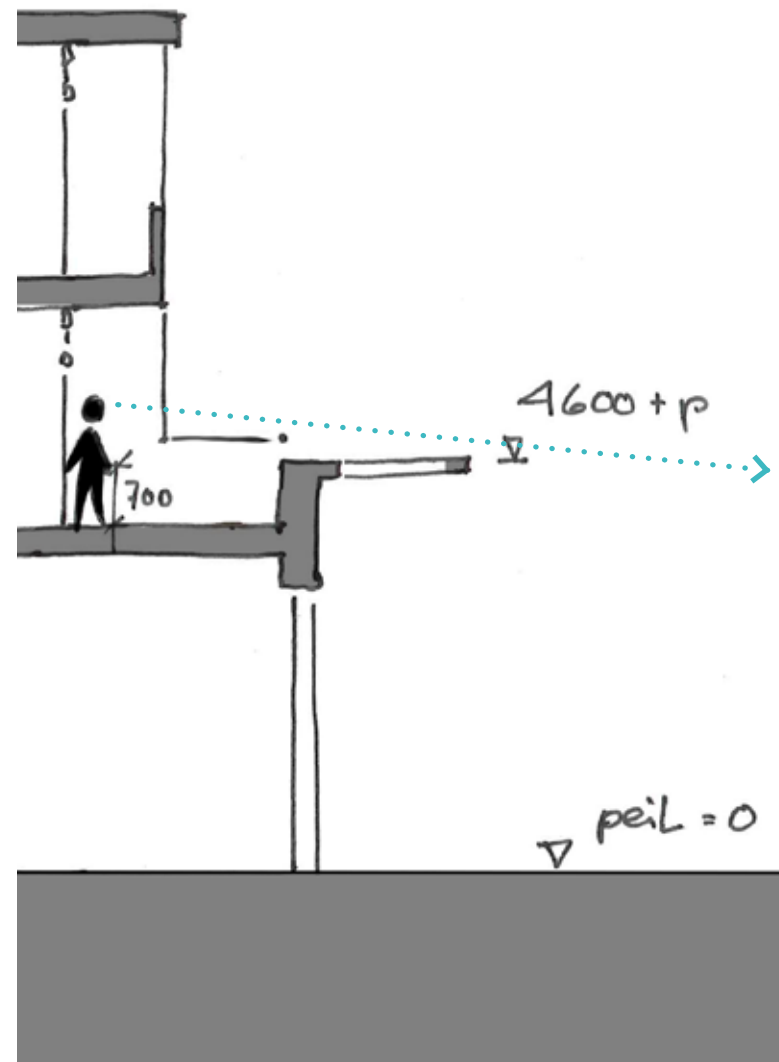

bestaande bebouwing

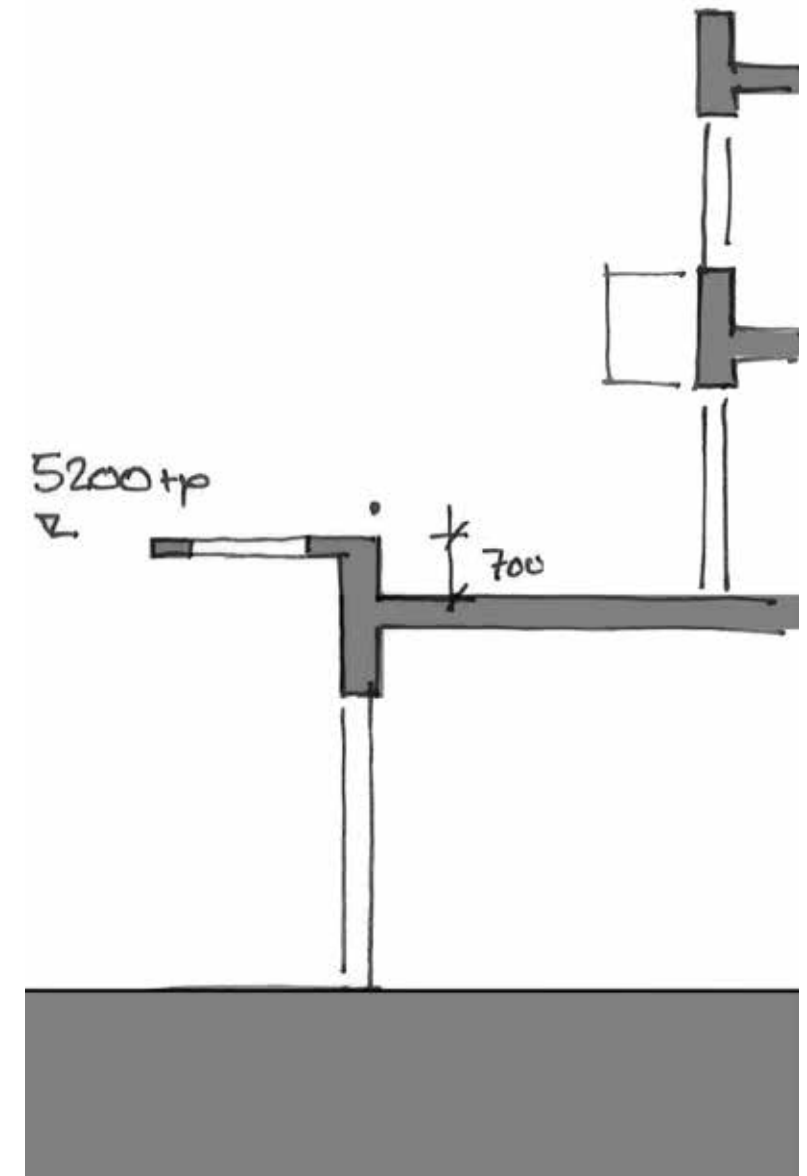

nieuwbouw



plein aanzicht

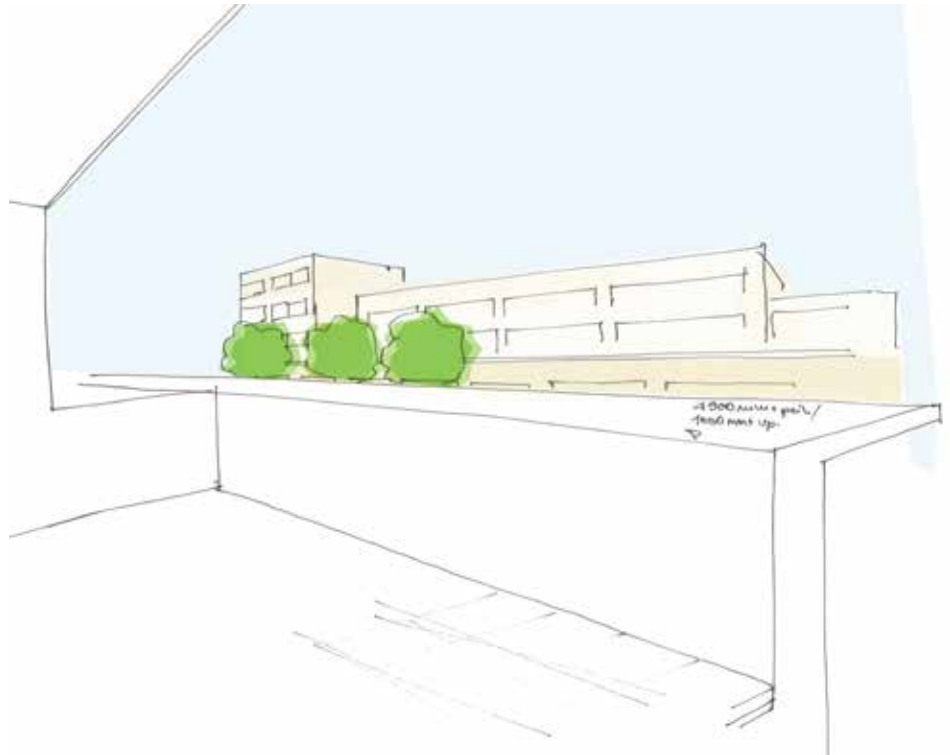

zicht vanuit balkon

onderzoek luifel | gelijke hoogte luifel rondom

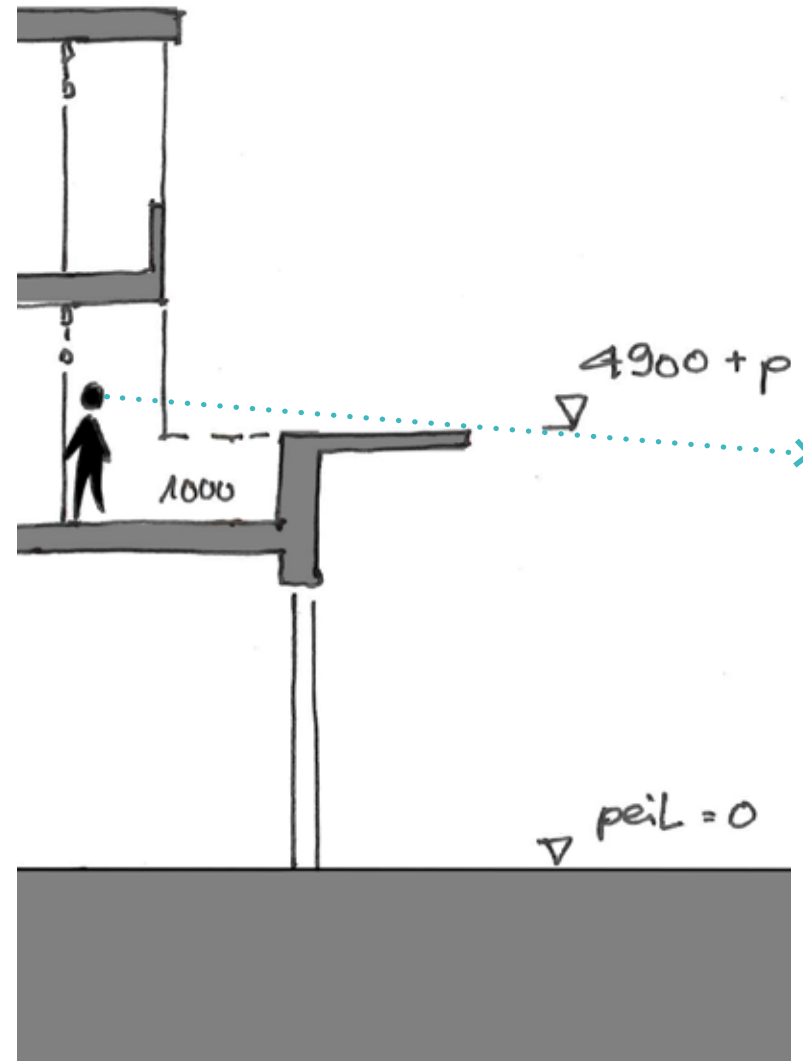

bestaande bebouwing

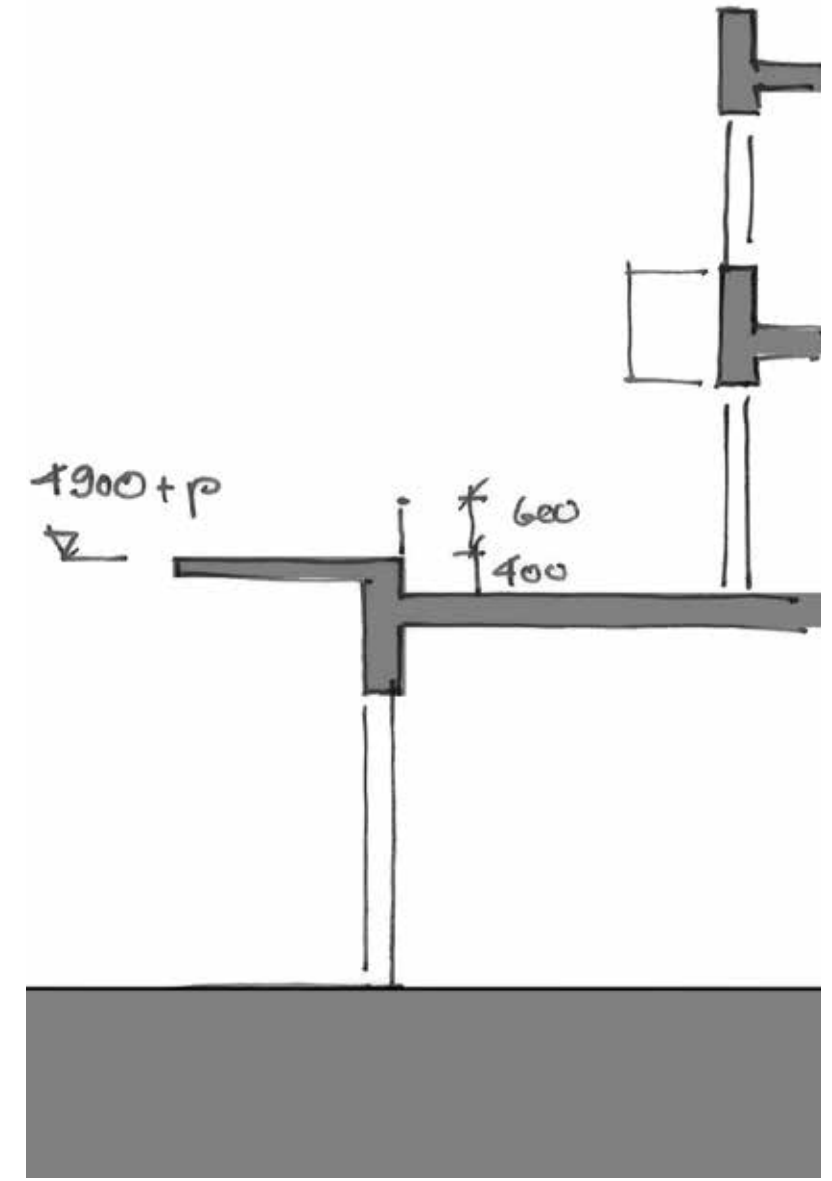

nieuwbouw

Den Haag | Duinzigt

huidige situatie



impressie



huidige situatie



impressie



huidige situatie



impressie



huidige situatie



impressie

